

SAMUEL HEATH

Product Number: V758-AIS

Description: Wall mounted spout - rough



Specification Drawing

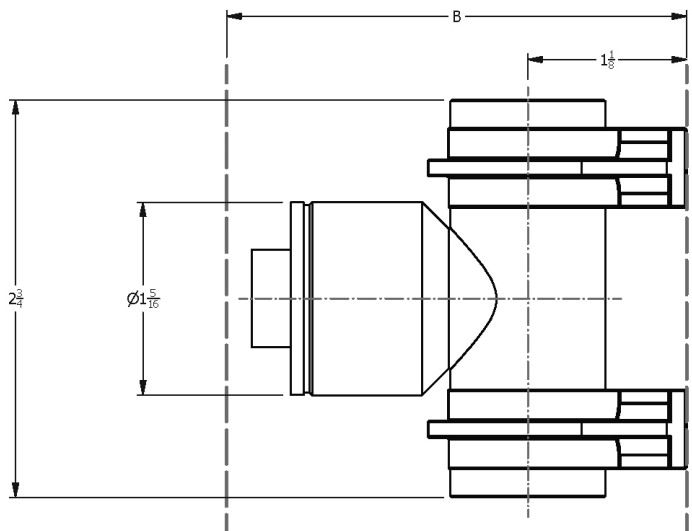
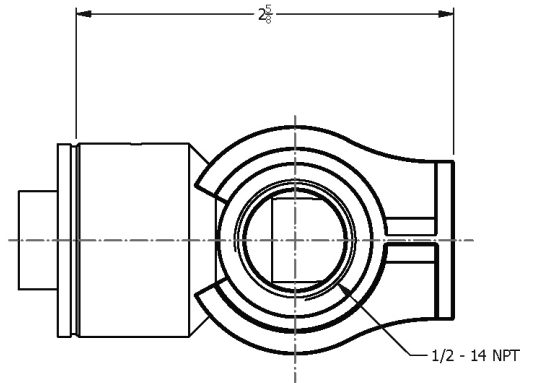
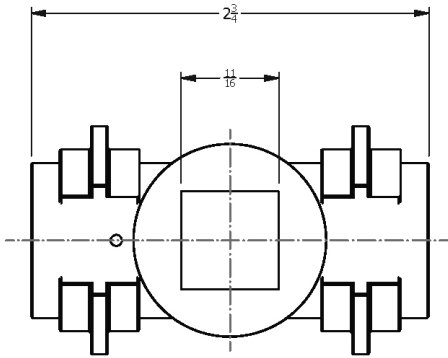

TRIM	DIMENSION 'B' RANGE
V746-1 & V746-2	3 7/8" TO 3 1/4"

UK Customer Service
Leopold Street
Birmingham
B12 0UJ
Tel: +44 121 766 4200
Email: info@samuel-heath.com

US Customer Service
Federal I.D. No. 58-1504682
Email: usa@samuel-heath.com

Specification Enquiries
Design Centre Chelsea Harbour
1st Floor, North Dome, London
SW10 0XE
Tel: 020 7352 0249
Email: showroom@samuel-heath.com

1-12/06/2019