

## LAGOS SQUARE DRAIN

### Features

- 15 gauge 316 Stainless Steel Grate = 1.8 mm
- Base made in ABS plastic.
- Works with 2" ABS, PVC or Cast Iron shower drain flange (not included).
- Center Drain is intended for use with traditional waterproofing methods.
- Hair Strainer Basket comes with every drain, fits inside the drain to collect hair and other debris, preventing pipe clogs.
- Grate can be removed completely for cleaning.

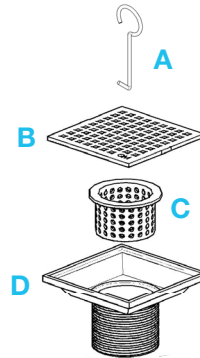

### Kit Includes:

- A** Lifting Key
- B** Grate
- C** Hair/Debris Strainer
- D** Base

### Specifications

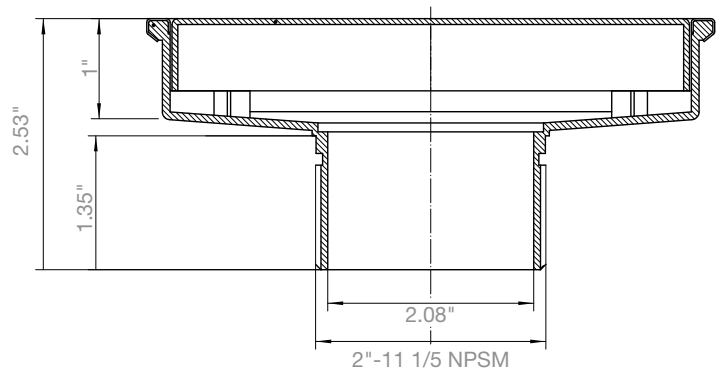
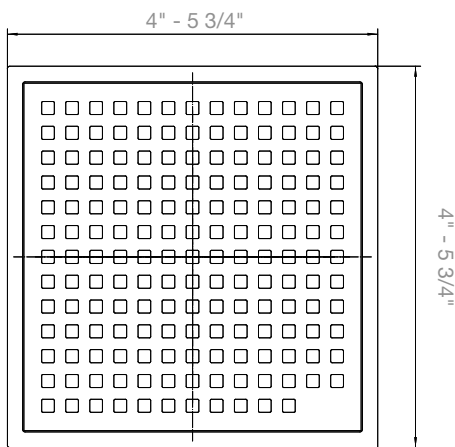

### Complete Kit

#### Mira

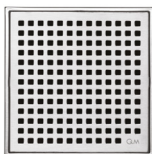

Length	Satin SKU	Polished SKU	Black SKU	Satin Gold SKU	Bronze SKU
4" x 4"	88.100.04 ST	88.100.04 PS	88.100.04 BK	88.100.04 GD	88.100.04 BZ
5 3/4" x 5 3/4"	88.100.06 ST	88.100.06 PS	88.100.06 BK	88.100.06 GD	88.100.06 BZ

**Note:** If modern waterproofing method is intended using a bonded flange, add a bonded flange adaptor. See page 132  
Installer must verify all rough-in dimensions prior to installation and consult local and national codes. Conformity and compliance to local and national codes are the responsibility of the installer. Dimensions are subject to Manufacturers tolerance and change without notice.  
We can assume no responsibility for use of superseded or void data.

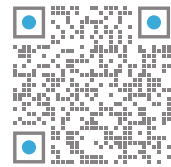

Installation Instructions,  
videos and more.

## LAGOS SQUARE DRAIN

### Features

- Base and Tile Insert Grate made in ABS plastic. Base and Grate Edges covered by stainless steel.
- Works with 2" ABS, PVC or Cast Iron shower drain flange (not included).
- Center Drain is intended for use with traditional waterproofing methods.
- Hair Strainer Basket comes with every drain, fits inside the drain to collect hair and other debris, preventing pipe clogs.
- Grate can be removed completely for cleaning.

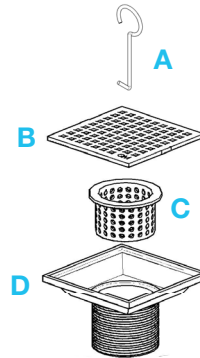

### Kit Includes:

- A** Lifting Key
- B** Grate
- C** Hair/Debris Strainer
- D** Base

### Specifications

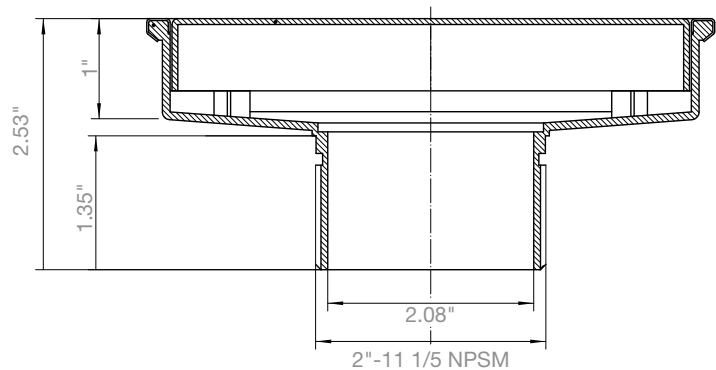
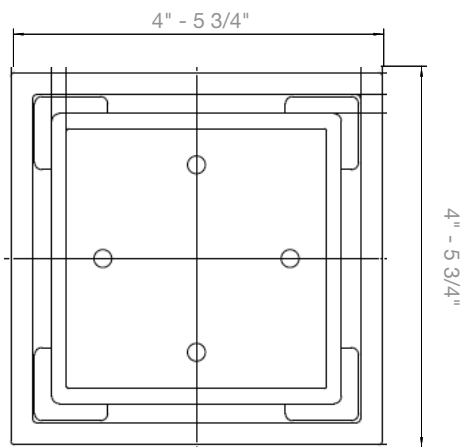

### Complete Kit

#### Veil



Length	Satin SKU	Polished SKU	Black SKU	Satin Gold SKU	Bronze SKU
4" x 4"	88.300.04 ST	88.300.04 PS	88.300.04 BK	88.300.04 GD	88.300.04 BZ
5 3/4" x 5 3/4"	88.300.06 ST	88.300.06 PS	88.300.06 BK	88.300.06 GD	88.300.06 BZ

\*Veil (Tile-In) grate accepts flooring material up to 1/2" thickness.

**Note:** If modern waterproofing is preferred, add: intended using a bonded flange, add QM bonded flange.

Installer must verify all rough-in dimensions prior to installation and consult local and national codes. Conformity and compliance to local and national codes are the responsibility of the installer. Dimensions are subject to Manufacturers tolerance and change without notice. We can assume no responsibility for use of superseded or void data.