

Date:

Client:

Project:

VOLA product: HV1+30



HV1+30

One-handle mixer with ceramic disc technology, height 150 mm, fixed spout with water saving aerator. Pipe size: 10 mm. Hole cut out size: 32 mm.

Flow

	Psi:	14.5	29.0	43.5	58.0	72.5
HV1+30	(gal/min)	0.8	1.1	1.3	1.3	1.3
HV1+30 ¹⁾	(gal/min)	0.7	1.0	1.2	1.2	1.2

¹⁾ USA standard

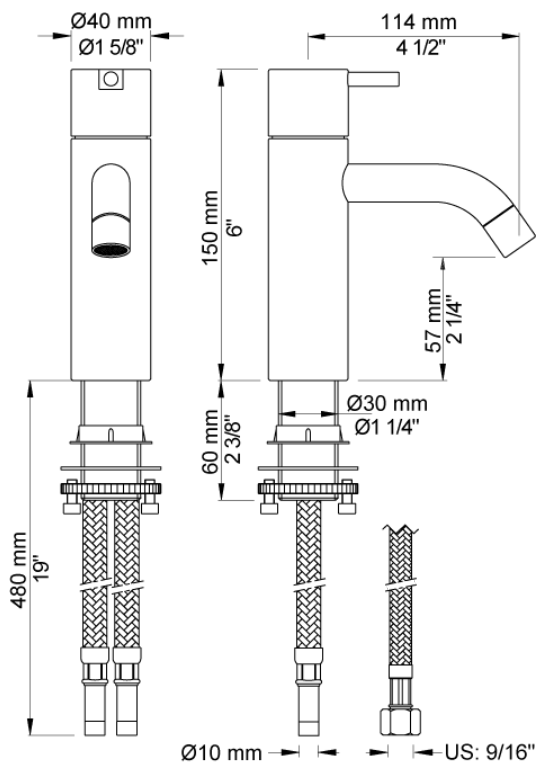

Available in colors

- Color 02, Grey
- Color 04, Light blue
- Color 05, Orange
- Color 06, Light green
- Color 08, Yellow
- Color 09, Dark grey
- Color 12, Mocca
- Color 14, Bright red
- Color 15, Dark blue
- Color 16, Polished chrome
- Color 17, Gloss black
- Color 18, White
- Color 19, Natural brass
- Color 20, Brushed chrome
- Color 21, Carmine red
- Color 25, Pink
- Color 27, Matt black
- Color 40, Brushed stainless steel