

**PRODUCT SPECIFICATIONS**

Elkay Gourmet Stainless Steel 54" x 22" x 10", Double Bowl Top Mount Sink. Sink is manufactured from 18 gauge 304 Stainless Steel with a Lustrous Highlighted Satin finish, Rear Center drain placement, and Sound Guard.

<b>Installation Type:</b>	Top Mount
<b>Material:</b>	304 Stainless Steel
<b>Special Features:</b>	Drainboard
<b>Finish:</b>	Lustrous Highlighted Satin
<b>Gauge:</b>	18
<b>Sound Deadening:</b>	Sound Guard
<b>Number of Bowls:</b>	2
<b>Sink Dimensions:</b>	54" x 22" x 10"
<b>Bowl 1 Dimensions:</b>	16" x 16" x 7-7/8"
<b>Bowl 2 Dimensions:</b>	14" x 18" x 9-7/8"
<b>Drain Size:</b>	3-1/2" (89mm)
<b>Drain Location:</b>	Rear Center
<b>Minimum Cabinet Size:</b>	57"
<b>Mounting Hardware:</b>	Part # 64090008 included for countertops up to 3/4" (19mm) thick
<b>Cutout Template #:</b>	<a href="#">1000001318</a>

Template is available for download at [elkay.com](http://elkay.com)

**Cutout Dimensions for Top Mount Installation:**

53-3/8" x 21-3/8" (1356mm x 543mm) with 1-1/2" (38mm) corner radius

**Hole Drilling Configurations:**

1-1/2" (38mm) Diameter Faucet Holes on 4" (102mm) Centers

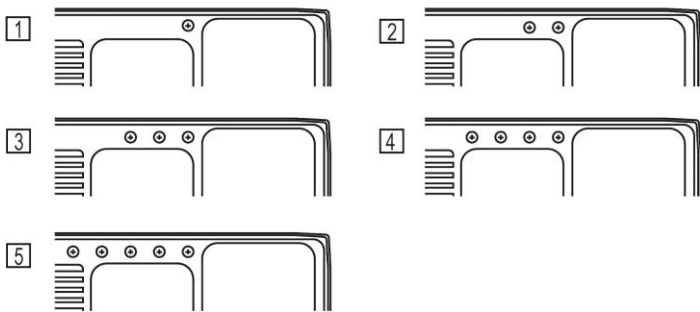

**Installation Profile:**

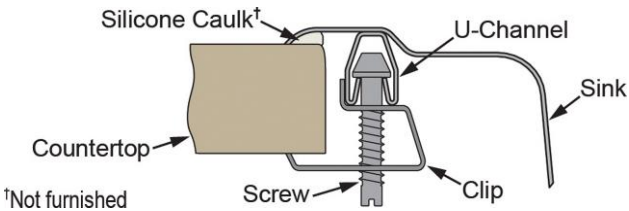

**AMERICAN PRIDE. A LIFETIME TRADITION.**

Like your family, the Elkay family has values and traditions that endure. For almost a century, Elkay has been a family-owned and operated company, providing thousands of jobs that support our families and communities.



Sinks are listed by IAPMO® as meeting the applicable requirements of the Uniform Plumbing Code®, International Plumbing Code®, and National Plumbing Code of Canada.

**Product Compliance:** ASME A112.19.3/CSA B45.4  
BUY AMERICAN ACT

[Clean and Care Manual \(PDF\)](#)

[Installation Instructions \(PDF\)](#)

[Limited Lifetime Warranty \(PDF\)](#)

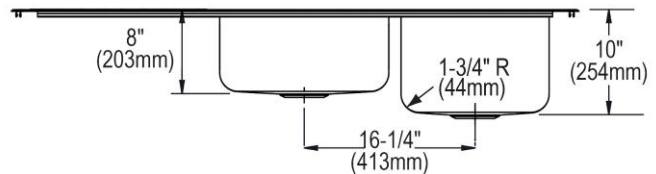
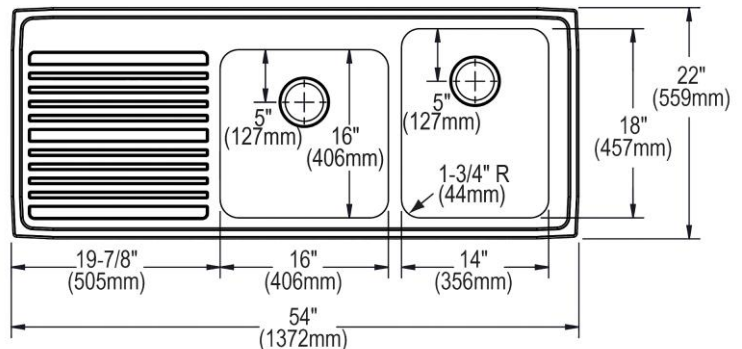

PART: \_\_\_\_\_ QTY: \_\_\_\_\_

PROJECT: \_\_\_\_\_

CONTACT: \_\_\_\_\_

DATE: \_\_\_\_\_

NOTES: \_\_\_\_\_

APPROVAL: \_\_\_\_\_

*In keeping with our policy of continuing product improvement, Elkay reserves the right to change product specifications without notice. Please visit [elkay.com](http://elkay.com) for the most current version of Elkay product specification sheets. This specification describes an Elkay product with design, quality, and functional benefits to the user. When making a comparison of other producers' offerings, be certain these features are not overlooked.*

**OPTIONAL ACCESSORIES**

<b>Bottom Grid:</b>	LKWOBG1418SS (small bowl), LKWOBG1616SS (large bowl)
<b>Cutting Board:</b>	CBR1418, CBS1418, CB1713, CBS1316
<b>Drain:</b>	LK99
<b>Faucet:</b>	LKGT1041, LKGT2041
<b>Hardware:</b>	LK364, LK463 (2 Required)
<b>Rinsing Basket:</b>	LKWRB1418SS, LKWRB1316SS, LKWERBSS
<b>Sinkmate:</b>	LKSM17, LKSMHOOK, LKSMSPONGE, LKSMHSL
<b>Soap Dispenser:</b>	LKGT1054

*In keeping with our policy of continuing product improvement, Elkay reserves the right to change product specifications without notice. Please visit [elkay.com](http://elkay.com) for the most current version of Elkay product specification sheets. This specification describes an Elkay product with design, quality, and functional benefits to the user. When making a comparison of other producers' offerings, be certain these features are not overlooked.*