

PRODUCT SPECIFICATIONS

Elkay Lustertone™ Classic Stainless Steel 26-1/2" x 18-1/2" x 10" Single Bowl Undermount Sink with Perfect Drain. Sink is manufactured from 18 gauge 304 Stainless Steel with a Lustrous Satin finish, Rear Center drain placement, and Sides and Bottom pads.

Installation Type:	Undermount
Material:	304 Stainless Steel
Special Features:	Perfect Drain
Finish:	Lustrous Satin
Gauge:	18
Sound Deadening:	Sides and Bottom pads
Number of Bowls:	1
Sink Dimensions:	26-1/2" x 18-1/2" x 11-1/2"
Bowl 1 Dimensions:	24" x 16" x 10"
Drain Size:	3-3/8" (86mm)
Drain Location:	Rear Center
Minimum Cabinet Size:	30"
Mounting Hardware:	Undermount brackets sold separately
Template Included:	Yes
Cutout Template #:	1000001376

Template is available for download at [elkay.com](#). CAD software will be required to open the template.

Perfect Drain: Seamlessly welded stainless steel collar eliminates the gap between a traditional drain and the sink for a more sanitary and gap free installation. Select garbage disposers can be installed on either sink bowl for user convenience. Please see our Garbage Disposer Compatibility Guide.

Installation Profile:

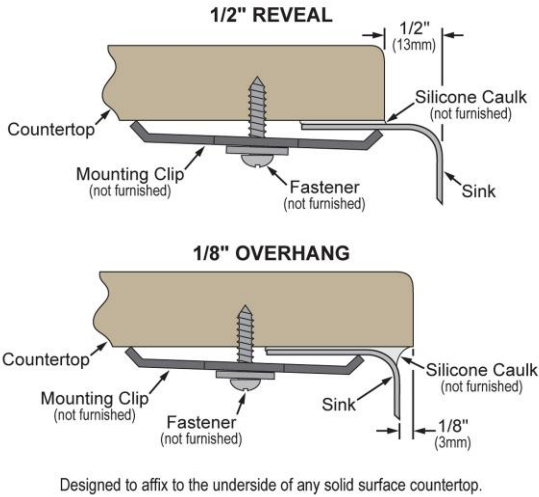

Designed to affix to the underside of any solid surface countertop.

PART: _____ QTY: _____
 PROJECT: _____
 CONTACT: _____
 DATE: _____
 NOTES: _____
 APPROVAL: _____



Included with Product: One LKPD1 Perfect Drain and strainer.

A Century of Tradition and Quality. For more than 100 years, Elkay has been making innovative products and providing exceptional customer care. We take pride in offering plumbing products that make life easier, inspire change and leave the world a better place.

Product Compliance: ASME A112.19.3/CSA B45.4
Buy American Act
Accessory: ASME A112.18.2/CSA B125.2



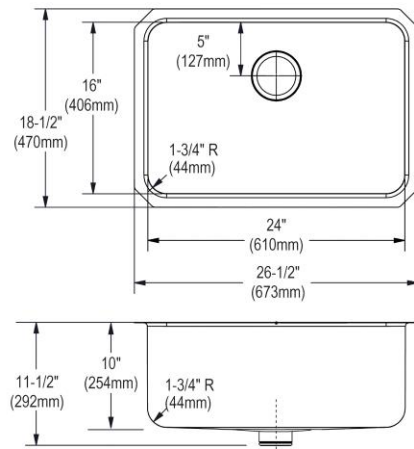

 Sinks are listed by IAPMO® as meeting the applicable requirements of the Uniform Plumbing Code®, International Plumbing Code®, and National Plumbing Code of Canada.

- [Clean and Care Manual \(PDF\)](#)
- [Installation Instructions \(PDF\) - 1000005239](#)
- [Installation Instructions \(PDF\) - 74180289 Disposer](#)
- [Installation Instructions \(PDF\) - 74180340-USA Drain](#)
- [Installation Instructions \(PDF\) - Garbage Disposer Compatibility Guide](#)
- [Warranty \(PDF\)](#)



In keeping with our policy of continuing product improvement, Elkay reserves the right to change product specifications without notice. Please visit [elkay.com](#) for the most current version of Elkay product specification sheets. This specification describes an Elkay product with design, quality, and functional benefits to the user. When making a comparison of other producers' offerings, be certain these features are not overlooked.



Included Accessories		
LKPD1	Elkay Perfect Drain Fitting Type 304 Stainless Steel Body and Strainer Spec Sheet (PDF)	
Optional Accessories		
LKWOBG2416SS	Elkay Stainless Steel 23" x 15" x 1-1/8" Bottom Grid Spec Sheet (PDF)	
CB1713	Elkay Hardwood 13-1/2" x 17" x 1" Cutting Board Spec Sheet (PDF)	
CBS1316	Elkay Hardwood 14-1/2" x 17" x 3/4" Cutting Board Spec Sheet (PDF)	
LKDS35	Elkay 3-1/2" Garbage Disposal Stopper / Strainer for use with Perfect Drain-Satin Finish Spec Sheet (PDF)	
LKDS99	Elkay 3-1/2" Garbage Disposal Stopper / Strainer for use with Perfect Drain-Chrome Polished Stainless Steel Spec Sheet (PDF)	
LKPDVR18B	Elkay Perfect Drain Chrome Plated Brass Body Vandal-resistant Strainer Spec Sheet (PDF)	

In keeping with our policy of continuing product improvement, Elkay reserves the right to change product specifications without notice. Please visit elkay.com for the most current version of Elkay product specification sheets. This specification describes an Elkay product with design, quality, and functional benefits to the user. When making a comparison of other producers' offerings, be certain these features are not overlooked.