

Cabrits

CAB-N-xx-OF

Top view

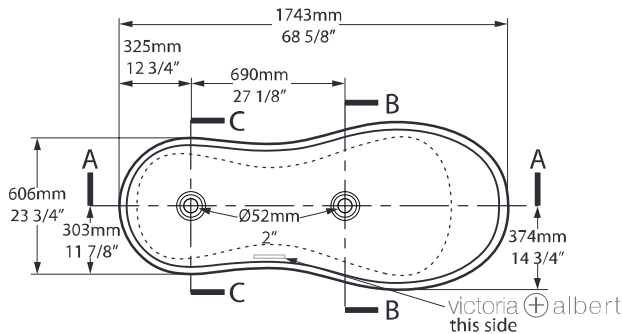

Front view

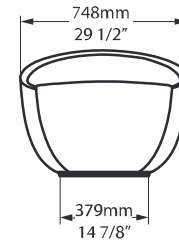

Section BB



Section CC



Side view

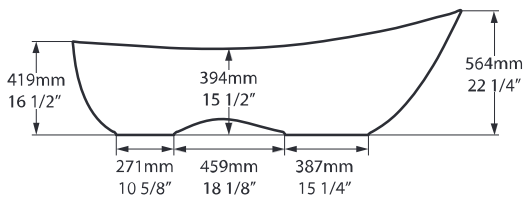

Section AA

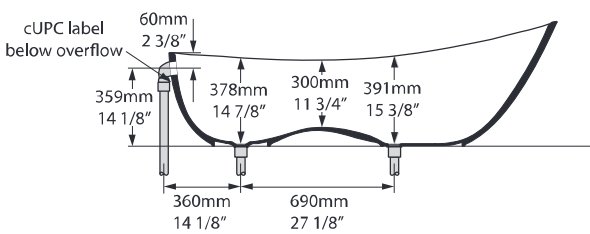

Section AA

Underside view

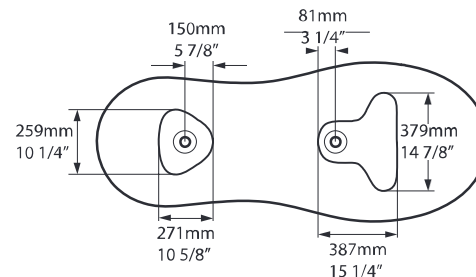

*All measurements subject to +/-5% tolerance

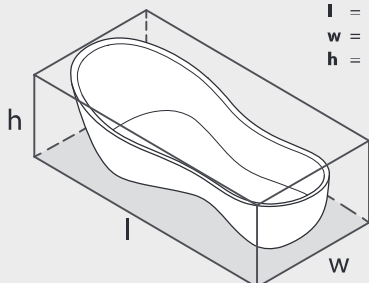

l = 1743mm / 68 5/8"
w = 748mm / 29 1/2"
h = 564mm / 22 1/4"

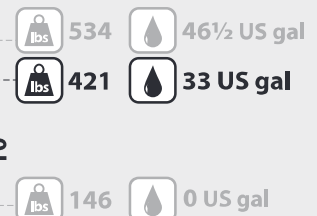
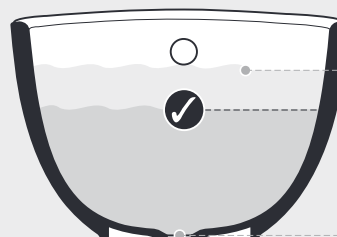

.dwg | .dxf | .skp www.vandabaths.com



Massachusetts Code: Approved
cUPC Listing by IAPMO: File No. 6574



VA/1181/08/Feb19