

# JASON<sup>®</sup>

HYDROTHERAPY

8328 MacArthur Dr. • North Little Rock, AR 72118  
 501.771.4477 • Fax: 501.771.2333  
 Customer Service: 800.255.5766  
 www.jasoninternational.com

## forma<sup>®</sup> Collection Specifications

### RD553PX

#### AirMasseur<sup>®</sup> & Soaking

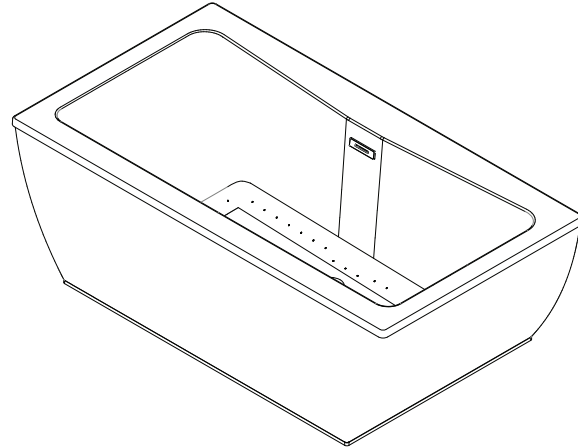
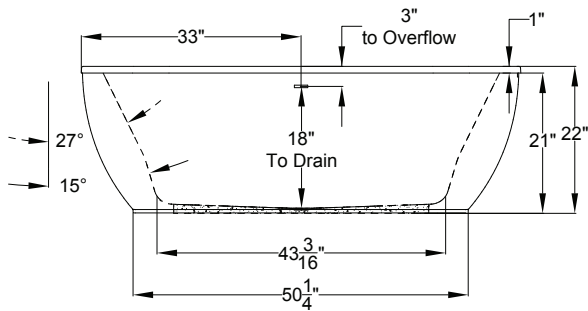
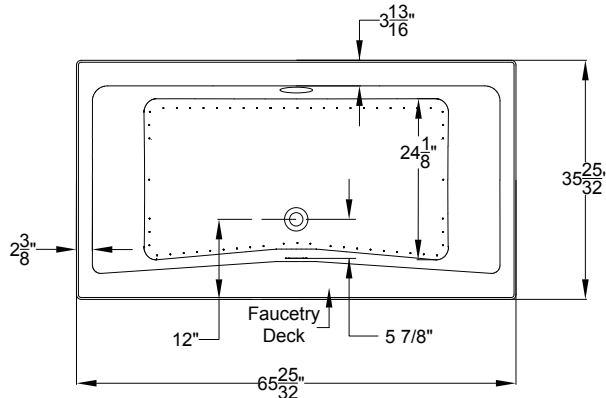

AIRMASSEUR BLOWER  
 MUST BE REMOTE  
 MOUNTED OR  
 INSTALLED IN AN AEC  
 EQUIPMENT CABINET.

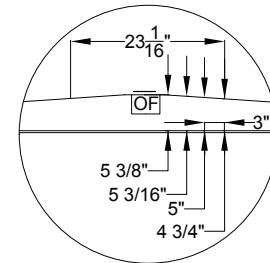
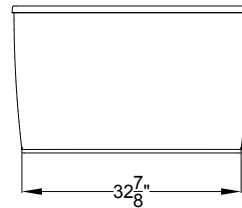

Faucetry Deck  
 Flat Dimensions

Patents received or pending.

Includes Linear Overflow Drain Assembly



Note: Dimensional Tolerances: ±1/4"

<b>Drop-in-Hole Size:</b>	N/A
<b>Operating Capacity:</b>	45 Gal.
<b>Overflow Capacity:</b>	88 Gal.
<b>Floor Loading / sq.ft.</b>	
<b>(Air/Soaking):</b>	53.8 / 50.9 lbs.
<b>Carton Wt. (Air/Soaking):</b>	185 / 147 lbs.
<b>Cube:</b>	36.6 ft. <sup>3</sup>

AirMasseur<sup>®</sup> Blower must be remote-mounted or installed in an Acrylic Equipment Cabinet.

**Construction:** Fiberglass reinforced acrylic bath with Level Form<sup>™</sup> full-support base.

*We provide products listed with Intertek ETL SEMKO (Edison Testing Laboratories) U.S. and Canadian and with International Association of Plumbing and Mechanical Officials (IAPMO). Consult factory with your listing requirements.*

<b>Standard</b>	 <p>A 120V system that includes a 1HP, variable speed air blower with integral air heater; automatic purge cycle; an electronic control that operates blower and blower speed for continuous, pulse or wave massage modes; and a 20-minute timer.</p>
<b>Premier</b>	 <p>A 120V system that includes a 1HP, variable speed air blower with integral air heater; (2) Chromatherapy mood lights; Automatic Ozone System; an electronic control that operates blower and blower speed for continuous, pulse or wave massage modes; automatic purge cycle; and a 20-minute timer. The keypad also operates the LED Chromatherapy mood lights.</p>
<b>Signature</b>	 <p>A 120V system that includes a 1HP, variable speed air blower with integral air heater; (2) Chromatherapy mood lights; Automatic Ozone System; a digital control with LCD display window; automatic purge cycle; and a 20-minute timer. Control keypad operates the blower and blower speed for continuous, pulse or wave massage modes, LED Chromatherapy mood lights and shows blower speed, water temperature and time remaining. Includes Bluetooth Sound Immersion.</p>