

ORION MOUS-654GPSB

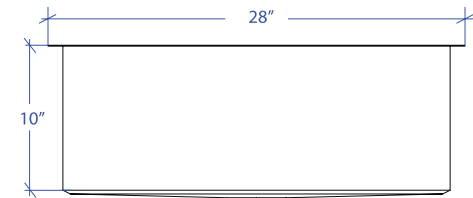

*Custom ADA compliant sinks are available

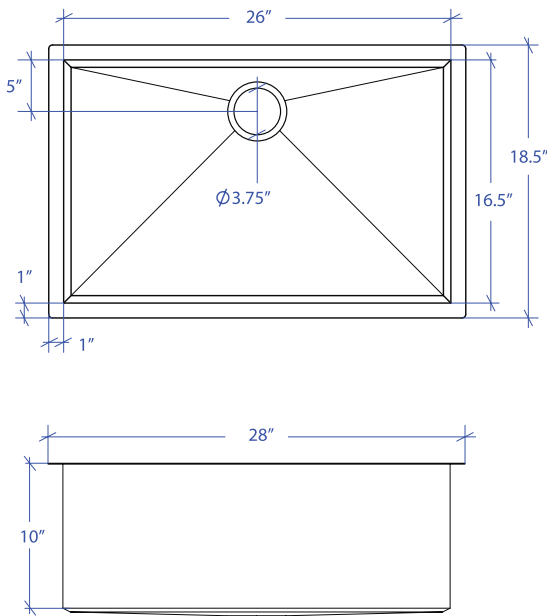

- FEATURES**
 16-gauge type 304 stainless steel
 Bevel basin design
- TECHNICAL INFORMATION**
 External dimension: 28" Lx18.5" Wx10" D
 Basin dimensions: 26" Lx16.5" Wx10" D
 Rim width: 1"
 Rim thickness: 1/16"
- FINISHES**
 Graphite PVD satin brushed stainless steel
- INSTALLATION OPTIONS**
 Under-mount
- MINIMUM CABINET SIZE (I.D.)**
 Under-mount 31"
- US DESIGN PATENT D618,324 S**
- DUAL-MOUNT INSTALLATION**

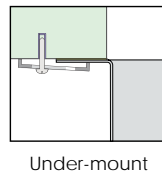

ACCESSORY OPTIONS

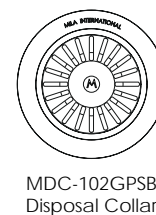
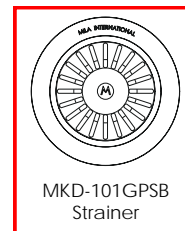
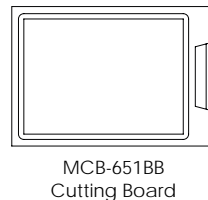
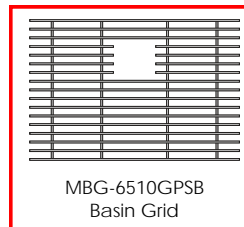

PROJECT INFORMATION			
Project			
Date	/ /	QTY	
Specifier			
Contact			
Note			

UNDER-MOUNT