

Series 586, 587 & 588 Cabinet Knobs

Finishes for Life
TARNISH-FREE GUARANTEED

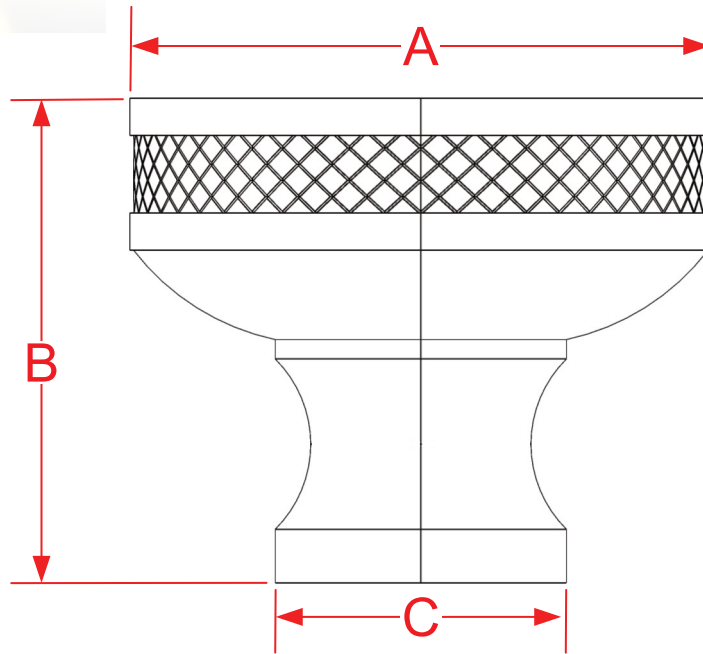

	A	B	C
Part #	Diameter	Projection	Base
586	1.0000"	1.0000"	0.5750"
587	1.2500"	1.1250"	0.6250"
588	1.5000"	1.2500"	0.7500"
Custom Sizing Available up to 2" Diameter			



Manufacturing Fine Architectural Hardware
in the USA Since 1927



Copyright
Colonial Bronze Company
All rights reserved
www.colonialbronze.com -
860.489.9233