

36 514 979 Product version from 4/1/2024

















- AQUAPRESSURE FLOW, max. flow rate 10 l/min (at 3 bar)
- water jet adjustable
- Function from: l/min

**Technical data:**

- cover plate 120 x 60 mm
- 1/2" connection

**Notes:**

- This product can help a building meet the requirements of Green Building Rating Systems, e.g. LEED®, BREEAM®, DGNB

	Chrome	36 514 979-00
	Brushed Platinum	36 514 979-06
	Platinum	36 514 979-08
	Dark Chrome	36 514 979-19
	Light Gold	36 514 979-26
	Brushed Light Gold	36 514 979-27
	Brushed Durabronze (23kt Gold)	36 514 979-28
	Matte Black	36 514 979-33
	Brushed Dark Brass	36 514 979-39
	Brushed Bronze	36 514 979-42
	Brushed Champagne (22kt Gold)	36 514 979-46
	Champagne (22kt Gold)	36 514 979-47
	Brushed Chrome	36 514 979-93
	Brushed Dark Platinum	36 514 979-99

Recommended miscellaneous

- Concealed wall elbow -** 35 085 970 90
- min. recess depth 90 mm
  - max. recess depth 163 mm



36 514 979 Product version from 4/1/2024

mm [inches]

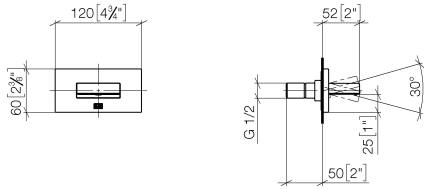

## Flow rate chart



## Trajectory diagram

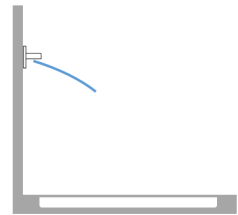
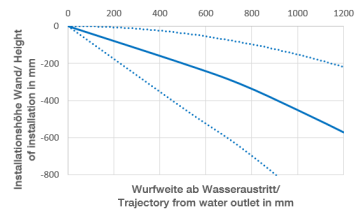

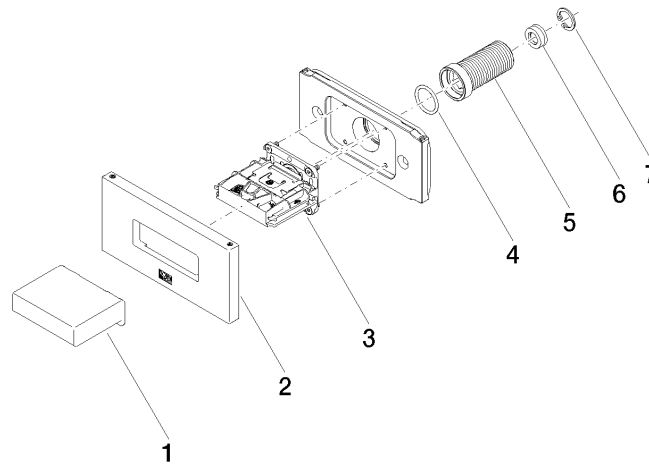

### Spare parts list

No.	Item Number	Name	Quantity used	Delivery time
5	09 24 04 336 90	nipple	1.00	2
3	90 29 03 088 00 90	insert	1.00	2
1	09 17 01 230-00	casing	1.00	10
7	09 16 01 014 90	ring	1.00	2
6	09 23 01 134 90	flow reducer	1.00	2
2	90 27 97 041 00-00	rosette	1.00	10
4	90 14 10 010 00 90	seal	1.00	2