









20 713 809



- 168mm projection
  - 1 1/4" pop-up waste
  - pivotable spout 360°
  - circular, air-enriched flow
  - height of mixer 280 mm
  - height up to aerator 191 mm
  - hole diameter valve 32 mm
  - hole diameter spout 35 mm
  - rosette Ø 60 mm
  - max. flow 4.5 l/min
  - lead-free
  - This product can help a building to meet requirements of Green Building Rating Systems, e.g. LEED®, BREEAM®, DGNB
- Only suitable for basins with an overflow.

	Platinum	20 713 809-08 0010
	Chrome	20 713 809-00 0010
	Brushed Platinum	20 713 809-06 0010
	Dark Chrome	20 713 809-19 0010
	Brushed Durabronze (23kt Gold)	20 713 809-28 0010
	Brushed Champagne (22kt Gold)	20 713 809-46 0010
	Champagne (22kt Gold)	20 713 809-47 0010
	Brushed Dark Platinum	20 713 809-99 0010

20 713 809

mm [inches]

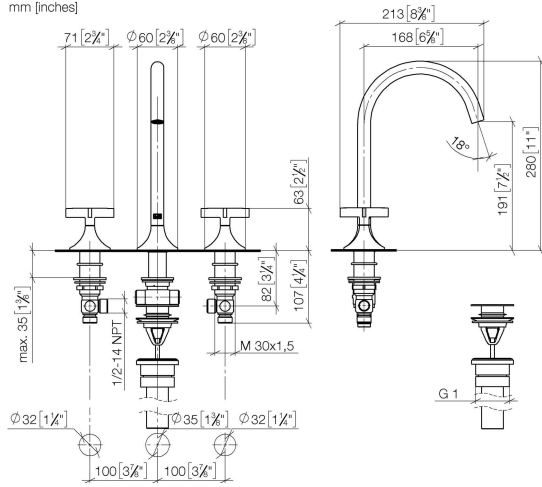

**Flow rate chart**

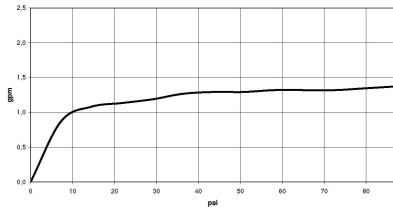

**Codes & Standards**

ADA

ASME  
A112.18.1/CSA  
B125.1

California Energy  
Commission  
(CEC)

NSF/ANSI 372

NSF/ANSI/CAN  
61

Water Sense

