

SPECIFICATIONS

Floormount Tub Filler

1.1700530

(1.1700530T Trim Only)

FEATURES:

- All brass construction
- Available in all finishes
- Warranty varies according to finish selection
- Rough kit P/N: 18.30.409
- Flow rate: 6.5 gpm at 60 psi
- Replacement cartridge P/N: 18.15.101
- Certified to meet or exceed the following codes and standards:
ASME A112.18.1/CSA B 125.1-2011

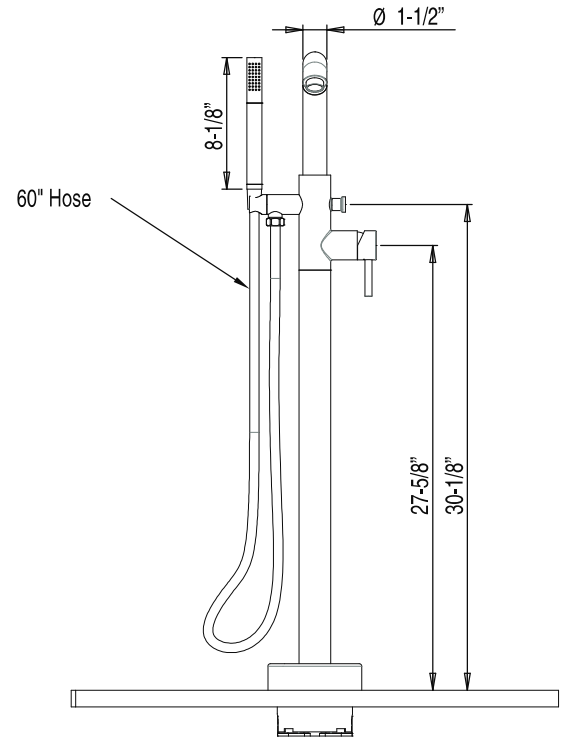
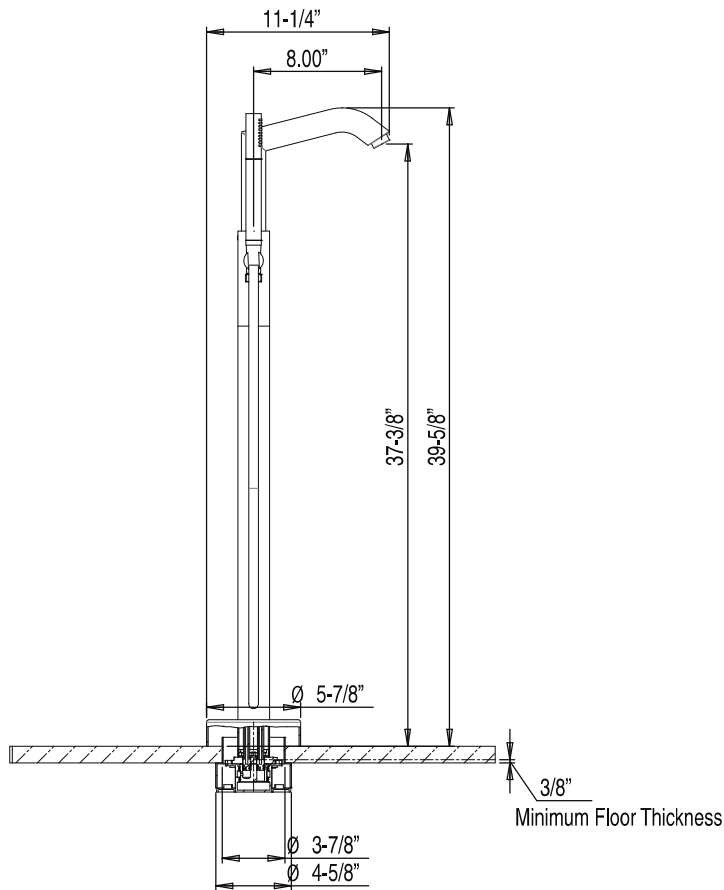

Note: Measurements are subject to change or cancellation. No responsibility is assumed for use of superseded or voided pages.