

**SPECIFICATIONS**

**Floormount Tub Filler**

**1.1100530**

(1.1100530T Trim Only)

**FEATURES:**

- All brass construction
- Available in all finishes
- Warranty varies according to finish selection
- Rough kit P/N: 18.30.409
- Flow rate: 6.5 gpm at 60 psi
- Replacement cartridge P/N: 18.15.101
- Certified to meet or exceed the following codes and standards:  
ASME A112.18.1/CSA B 125.1-2011

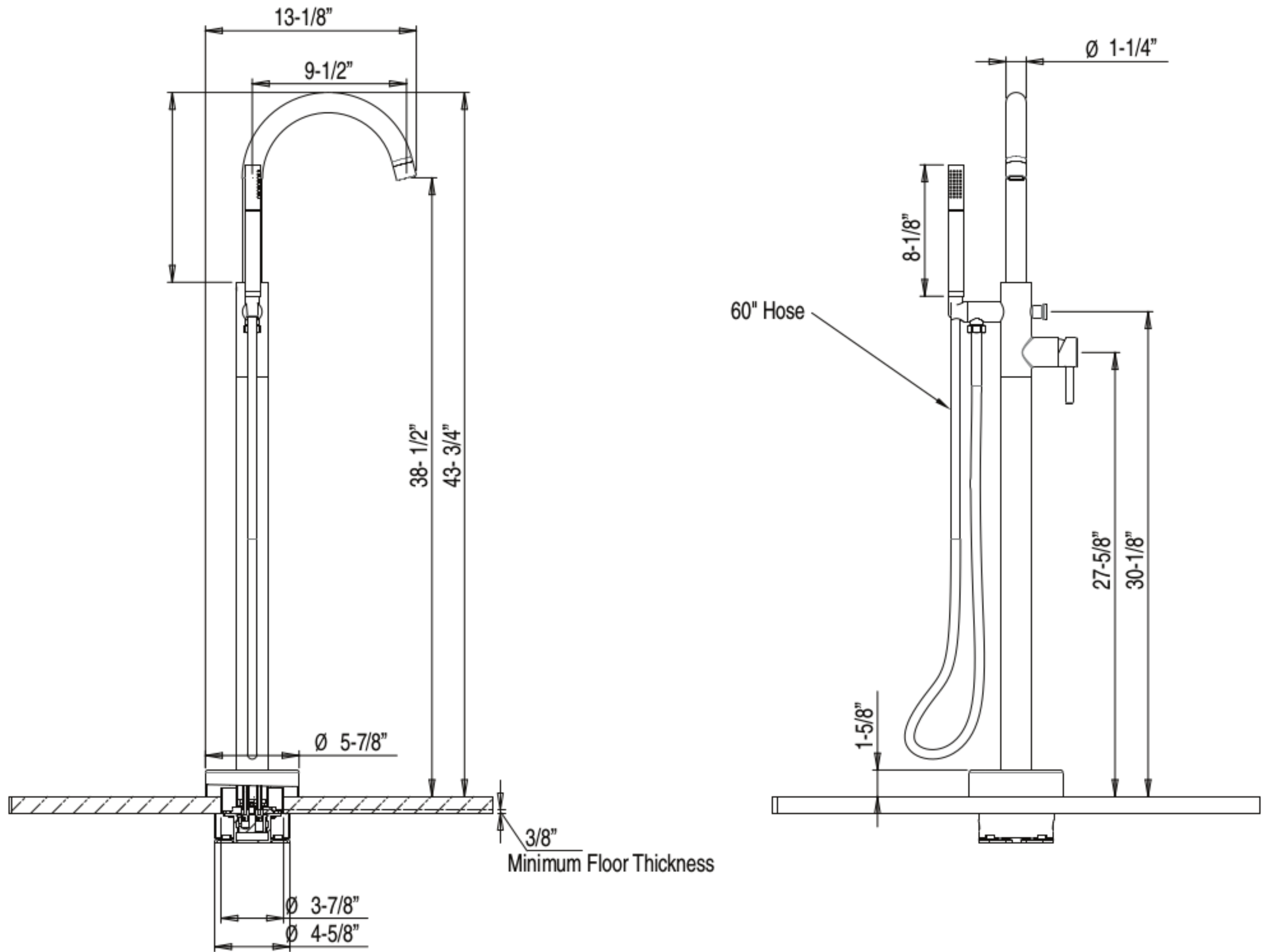

Note: Measurements are subject to change or cancellation. No responsibility is assumed for use of superseded or voided pages.