

AXOR ShowerSolutions

Overhead shower 250/250 2jet ceiling

Surfaces: **Chrome** Article Number: **35313000**



product features

- shower head size: 250 x 250 mm
- spray type: PowderRain, Intense PowderRain
- Select button on thermostat
- dynamic spray nozzles move out while using
- material spray disc: metal
- maximum flow rate at 3 bar: 17 l/min
- flow rate PowderRain spray (at 3 bar): 17 l/min
- flow rate Intense PowderRain (at 3 bar): 15 l/min
- minimum flow pressure: 1,5 bar
- overhead shower removable for cleaning
- installation: flush with the ceiling
- connection dimension: DN15

Technology



Design awards



reddot winner 2020



reddot winner 2021

Product image

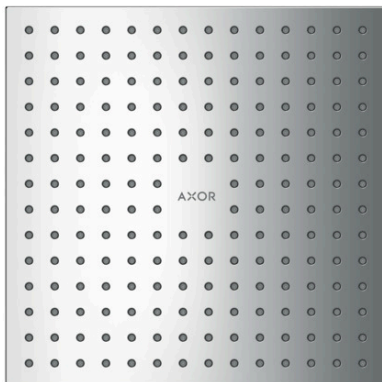

Scale drawing

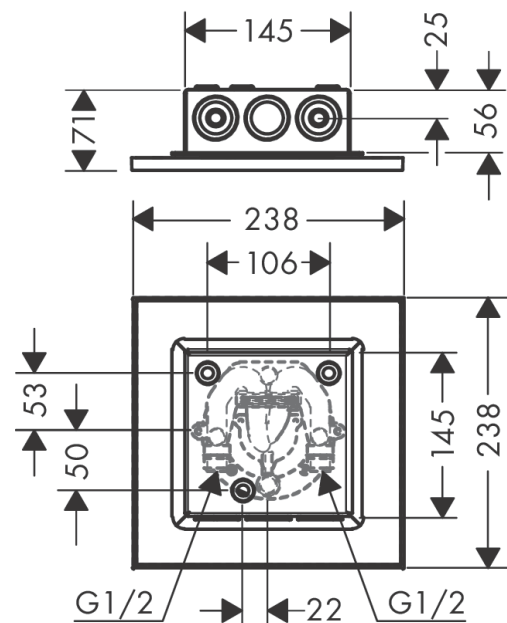

AXOR ShowerSolutions
Overhead shower 250/250 2jet ceiling
 Surfaces: **Chrome** Article Number: **35313000**



Flowchart

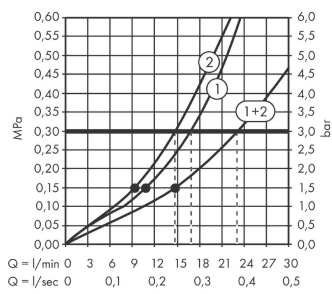

The consumption was measured in combination with the appropriate fittings (thermostat/mixer/ in-wall valve) to reflect actual application in practice.

AXOR ShowerSolutions
Overhead shower 250/250 2jet ceiling
 Surfaces: **Chrome** Article Number: **35313000**



Installation examples

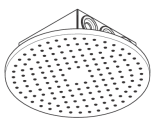

AXOR 250 2jet
35298000

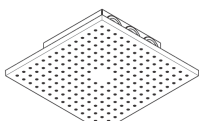

AXOR 250/250 2jet
35313000

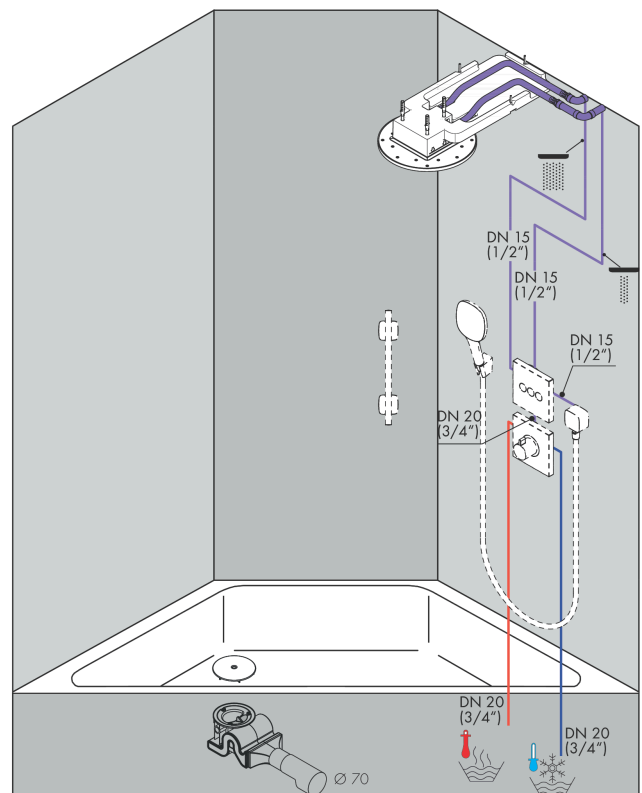
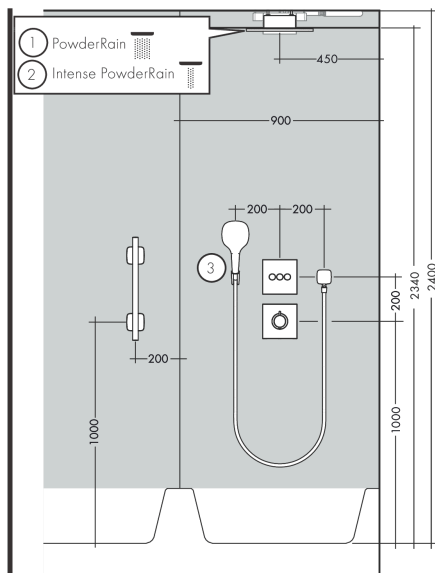
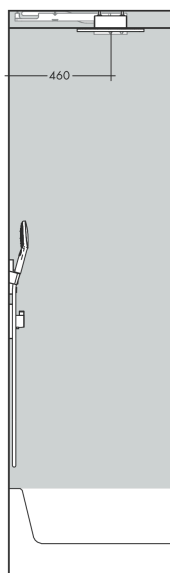
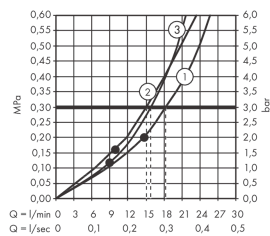

AXOR ShowerSolutions
Overhead shower 250/250 2jet ceiling
Surfaces: **Chrome** Article Number: **35313000**



Exploded Drawing

Year of production: >02/19

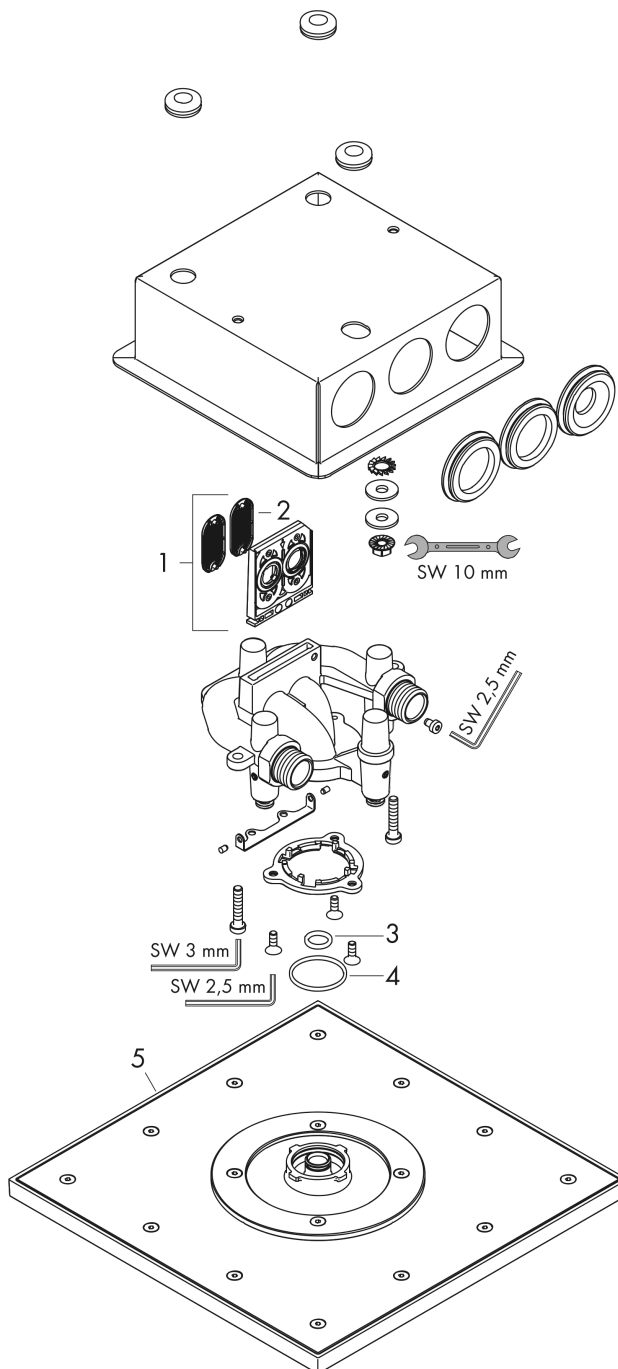

AXOR ShowerSolutions
Overhead shower 250/250 2jet ceiling
 Surfaces: **Chrome** Article Number: **35313000**



Spare part list

Year of production: >02/19

Pos.		Article Number	Price	PU
1	service unit	93423000	-	1
2	filter	93402000	-	1
3	O-ring 11x2	98127000	-	1
4	O-Ring 28x2	98194000	-	1
5	head shower	93460000	-	1