

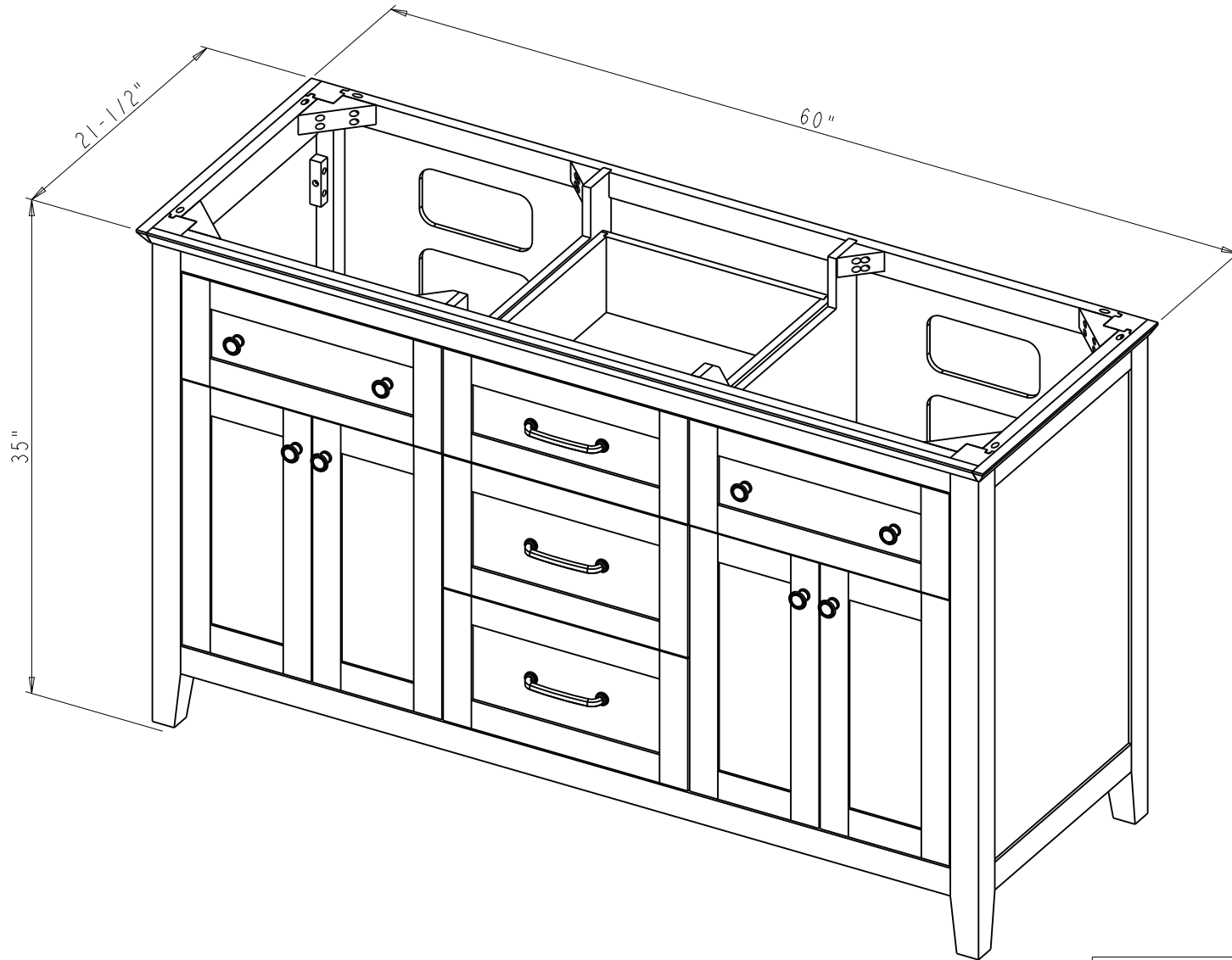

Specification:

1. Material: Plywood + Birch
2. Finish: See Table
3. Hardware: See Table
4. Slides: USE58-300-18 + US-CLIP-4W ( 5 Sets )
5. Shelf Supports: 1707BN ( 8 PCS )
6. Drawer Boxes: 5/8" Rubber wood  
Clear color  
Dovetail
7. Tipout Hinge: 700.0536.25(4PCS)+600.1234.05 ( 4 PCS )  
Door Hinge: 700.0536.25(4PCS)+700.0537.25(4 PCS)  
+ 600.1234.05 ( 8 PCS )
8. Lid Stay ( 2 PCS )
9. The tolerance is +/- 1/8"



Item number	Finish	Deco Hardware			
		Item number	Qty	Item number	Qty
VN2CHA-60-CH-NT	Chocolate	527-128SN	3	Z110-SN	8
VN2CHA-60-GR-NT	Grey	527-128SN	3	Z110-SN	8
VN2CHA-60-WH-NT	White	527-128SN	3	Z110-SN	8

<p><b>hardware resources</b></p> <p><small>PROPRIETARY AND CONFIDENTIAL</small></p> <p><small>THE INFORMATION CONTAINED IN THIS DRAWING IS THE SOLE PROPERTY OF HARDWARE RESOURCES INC. ANY REPRODUCTION IN PART OR AS A WHOLE WITHOUT THE WRITTEN PERMISSION OF HARDWARE RESOURCES INC. IS PROHIBITED.</small></p>	ITEM#: VN2CHA-60D		MATERIAL:		
	FINISH:		WEIGHT: 0 g		
	TOLERANCE UNLESS OTHERWISE SPECIFIED: X ±0.20 X.X ±0.10 X.XX ±0.05 ANGULAR: ±0.5°		UNITS:	DRAWN BY: <b>Tony.Huang</b>	DATE: Aug-06-21
	DO NOT SCALE DRAWING		SIZE:	APPROVED BY:	DATE:
		SHEET:	RELEASE LEVEL:	REVISION:	

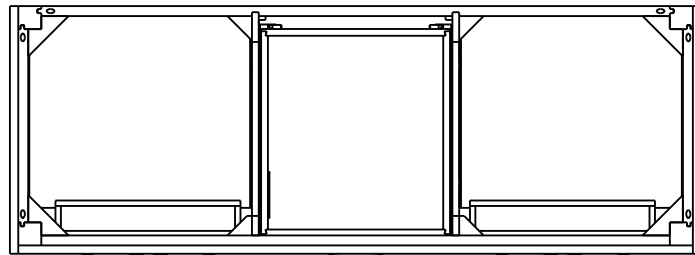
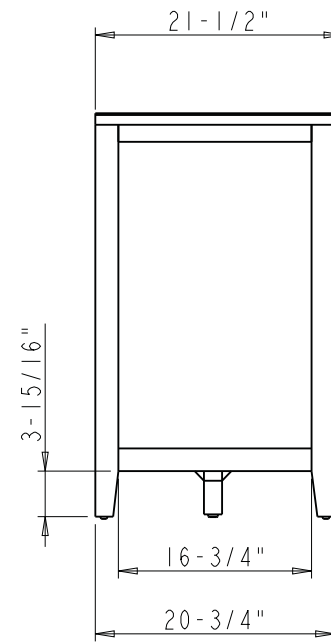
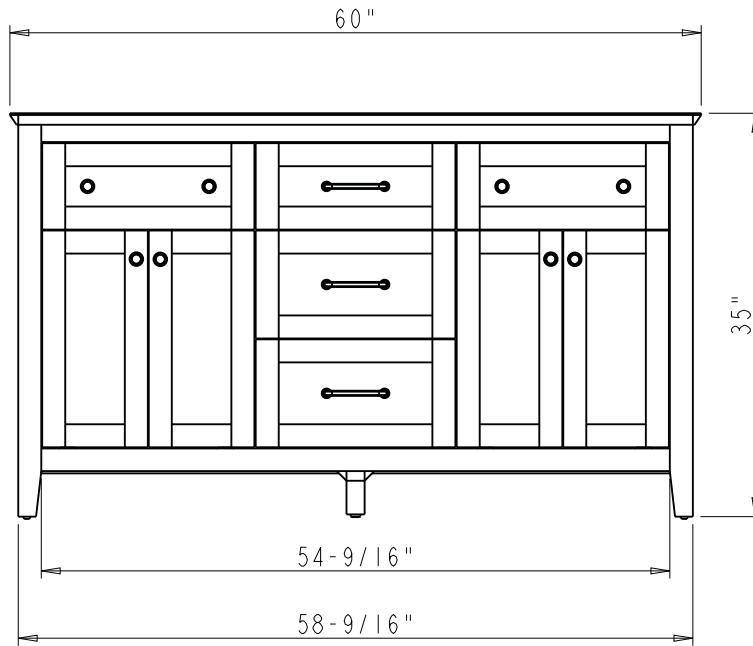

 <p><b>PROPRIETARY AND CONFIDENTIAL</b></p> <p>THE INFORMATION CONTAINED IN THIS DRAWING IS THE SOLE PROPERTY OF HARDWARE RESOURCES INC. ANY REPRODUCTION IN PART OR AS A WHOLE WITHOUT THE WRITTEN PERMISSION OF HARDWARE RESOURCES INC. IS PROHIBITED.</p> <p>DO NOT SCALE DRAWING</p>	ITEM#: VN2CHA-60D		MATERIAL:		
	FINISH:		WEIGHT: 0 g		
	TOLERANCE UNLESS OTHERWISE SPECIFIED: X ±0.20 X.X ±0.10 X.XX ±0.05 ANGULAR: ±0.5°		UNITS:	DRAWN BY: <i>Hugo.cai</i>	DATE: Mar-12-20
	SHEET:		APPROVED BY:	DATE:	REVISION:
		RELEASE LEVEL:	PROJECTION 		



 <p><b>PROPRIETARY AND CONFIDENTIAL</b></p> <p>THE INFORMATION CONTAINED IN THIS DRAWING IS THE SOLE PROPERTY OF HARDWARE RESOURCES INC. ANY REPRODUCTION IN PART OR AS A WHOLE WITHOUT THE WRITTEN PERMISSION OF HARDWARE RESOURCES INC. IS PROHIBITED.</p> <p>DO NOT SCALE DRAWING</p>	ITEM#: VN2CHA-60D		MATERIAL:	
	FINISH:		WEIGHT: 0 g	
	TOLERANCE UNLESS OTHERWISE SPECIFIED: X ±0.20 X.X ±0.10 X.XX ±0.05 ANGULAR: ±0.5°		PROJECTION 	
	UNITS:		DRAWN BY: <i>Hugo.cai</i>	
SIZE:		APPROVED BY:		DATE: Mar-12-20
SHEET:		RELEASE LEVEL:		REVISION: