

FLATIRON MUS-656GPSB

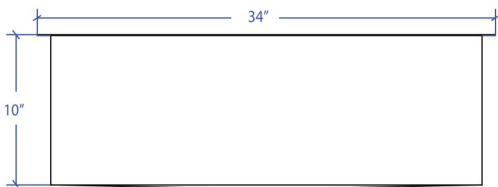

*Custom ADA compliant versions are available

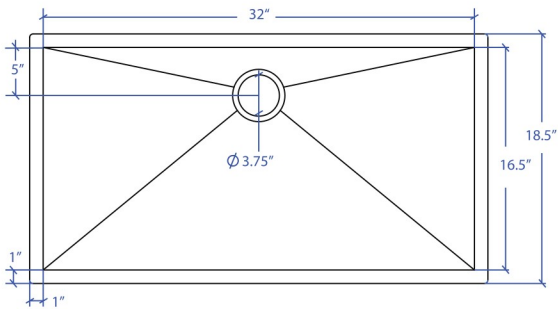

- **FEATURES**
16-gauge type 304 stainless steel
90° zero radius design
- **TECHNICAL INFORMATION**
External dimension: 34"Lx18.5"Wx10"D
Basin dimensions: 32"Lx16.5"Wx10"D
- **FINISHES**
Graphite PVD Satin Brushed stainless steel
- **INSTALLATION OPTIONS**
Under-mount
- **MINIMUM CABINET SIZE (I.D.)**
Under-mount 37"

• DUAL-MOUNT INSTALLATION

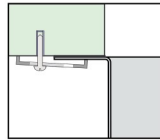

Under-mount

• ACCESSORY OPTIONS

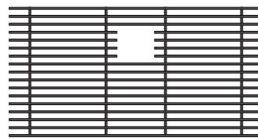

MBG-6513GPSB
Basin Grid

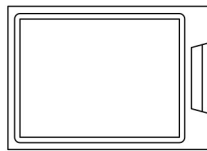

MCB-651BB
Cutting Board

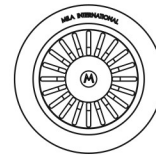

MKD-101GPSB
Strainer

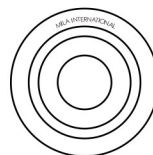

MDC-101GPSB
Disposal Collar

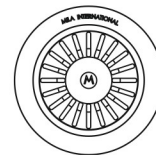

MDC-102GPSB
Disposal Collar

PROJECT INFORMATION			
Project			
Date	/ /	QTY	
Specifier			
Contact			
Note			

UNDER-MOUNT