

ORION MOUS-504GPSB

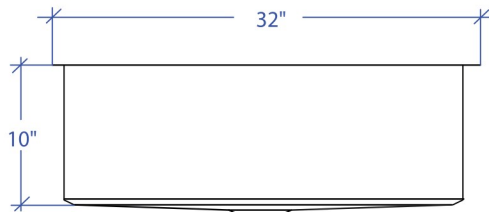

*Custom ADA compliant sinks are available

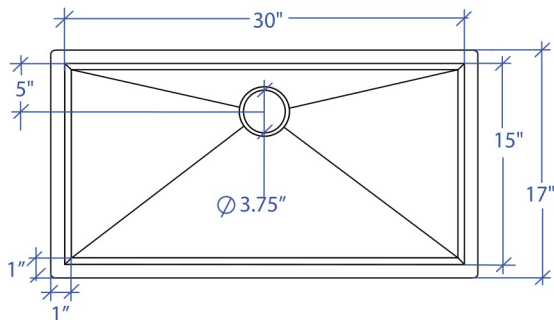

• FEATURES

16-gauge type 304 stainless steel
Bevel basin design

• TECHNICAL INFORMATION

External dimension: 32"Lx17"Wx10"D
Basin dimensions: 30"Lx15"Wx10"D

• FINISHES

Graphite PVD Satin Brushed stainless steel

• INSTALLATION OPTIONS

Under-mount

• MINIMUM CABINET SIZE (I.D.)

Under-mount 35"

• US DESIGN PATENT D618,324 S

• DUAL-MOUNT INSTALLATION

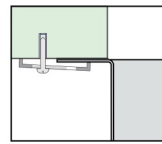

Under-mount

• ACCESSORY OPTIONS

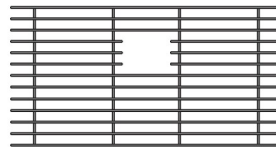

MBG-056GPSB
Basin Grid

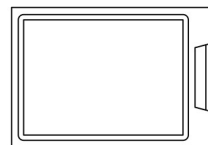

MCB-501BB
Cutting Board

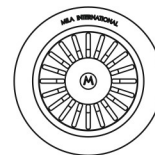

MKD-101GPSB
Strainer

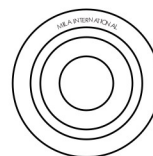

MKD-101GPSB
Disposal Collar

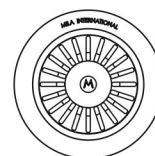

MDC-102GPSB
Disposal Collar

PROJECT INFORMATION			
Project			
Date	/ /	QTY	
Specifier			
Contact			
Note			