





Specification:

1. Material: Plywood + Birch
2. Finish: See Table
3. Hardware: See Table
4. Slides: USE58-300-18 + US-CLIP-4W ( 1 Sets )
5. Shelf Supports: 1707BN ( 4 PCS )
6. Drawer Boxes: 5/8" Rubber wood  
Clear color  
Dovetail
7. Tipout Hinge: 700.0536.25 + 600.1234.05 ( 2 Sets )  
Door Hinge: 700.0537.25 + 600.1234.05 ( 2 Sets )
8. Lid Stay ( 1 PC )
9. The tolerance is +/- 1/8"

Item number	Finish	Deco Hardware	
		Item number	Qty
VN2CHA-24-BL-NT	Blue	658SBZ	3
VN2CHA-24-CH-NT	Chocolate	Z110-SN	3
VN2CHA-24-GR-NT	Grey	Z110-SN	3
VN2CHA-24-WH-NT	White	Z110-SN	3

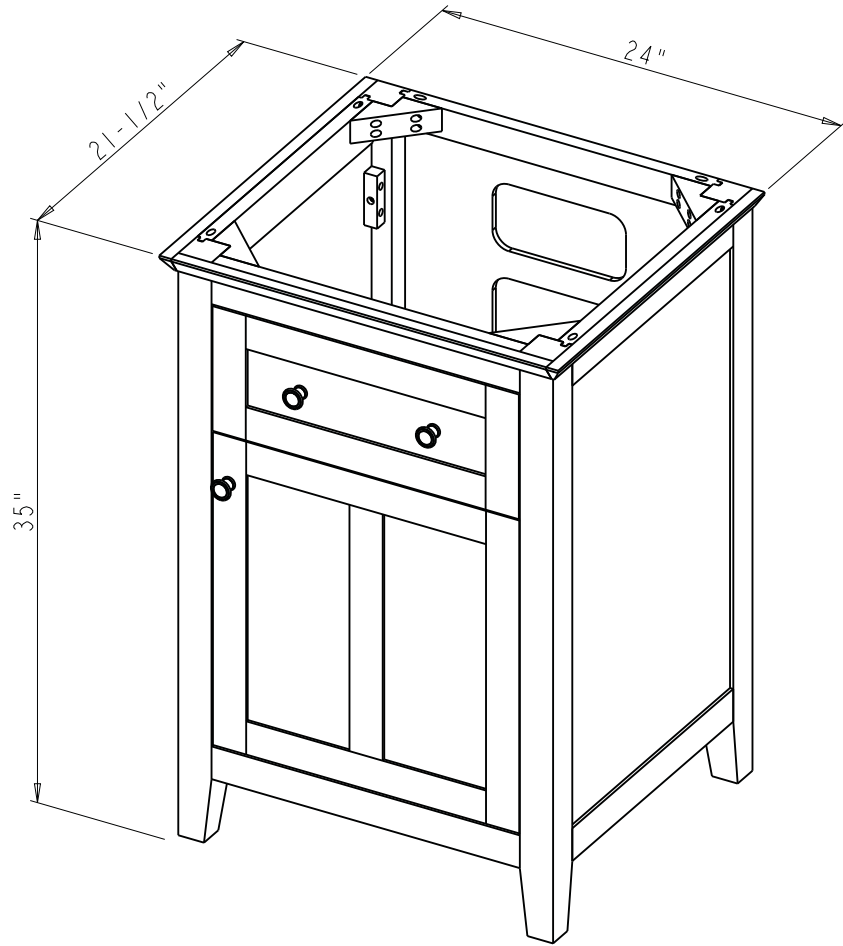
 <b>PROPRIETARY AND CONFIDENTIAL</b> THE INFORMATION CONTAINED IN THIS DRAWING IS THE SOLE PROPERTY OF HARDWARE RESOURCES INC. ANY REPRODUCTION IN PART OR AS A WHOLE WITHOUT THE WRITTEN PERMISSION OF HARDWARE RESOURCES INC. IS PROHIBITED.	ITEM#: VN2CHA-24	MATERIAL:	
	FINISH:	WEIGHT: 0 g	
	TOLERANCE UNLESS OTHERWISE SPECIFIED: X ±0.20 X.X ±0.10 X.XX ±0.05 ANGULAR: ±0.5°	UNITS:	PROJECTION 
	DO NOT SCALE DRAWING	DRAWN BY: Tony.Huang	DATE: Aug-09-21
	APPROVED BY:	DATE:	
	RELEASE LEVEL:	REVISION:	



 <b>PROPRIETARY AND CONFIDENTIAL</b> THE INFORMATION CONTAINED IN THIS DRAWING IS THE SOLE PROPERTY OF HARDWARE RESOURCES INC. ANY REPRODUCTION IN PART OR AS A WHOLE WITHOUT THE WRITTEN PERMISSION OF HARDWARE RESOURCES INC. IS PROHIBITED.	ITEM#: VN2CHA - 24		MATERIAL:		
	FINISH:		WEIGHT: 0 g		
	TOLERANCE UNLESS OTHERWISE SPECIFIED: X ±0.20 X.X ±0.10 X.XX ±0.05 ANGULAR: ±0.5° DO NOT SCALE DRAWING		UNITS:	DRAWN BY: <i>Hugo.cai</i>	DATE: Mar - 12 - 20
	SHEET:		APPROVED BY:	DATE:	REVISION:
PROJECTION 		RELEASE LEVEL:			

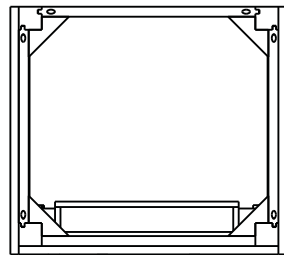
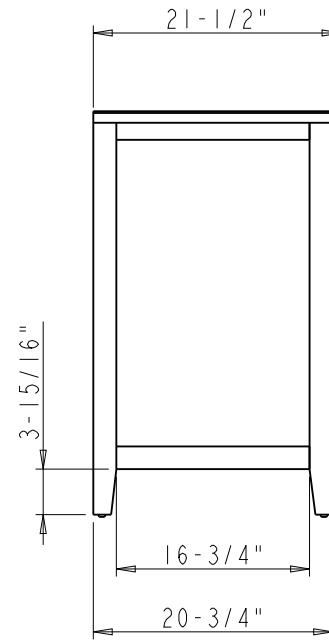
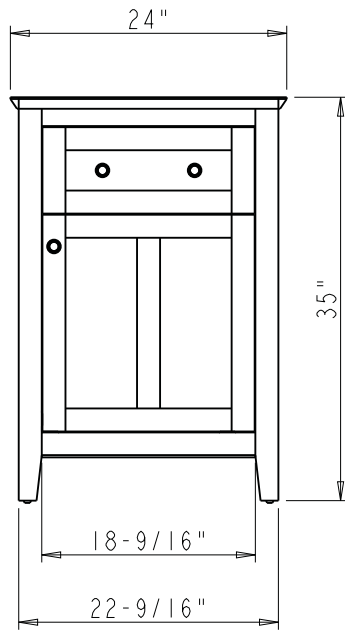

 <b>PROPRIETARY AND CONFIDENTIAL</b> THE INFORMATION CONTAINED IN THIS DRAWING IS THE SOLE PROPERTY OF HARDWARE RESOURCES INC. ANY REPRODUCTION IN PART OR AS A WHOLE WITHOUT THE WRITTEN PERMISSION OF HARDWARE RESOURCES INC. IS PROHIBITED. DO NOT SCALE DRAWING	ITEM#: VN2CHA - 24		MATERIAL:		
	FINISH:		WEIGHT: 0 g		
	TOLERANCE UNLESS OTHERWISE SPECIFIED: X ±0.20 X.X ±0.10 X.XX ±0.05 ANGULAR: ±0.5°		UNITS:	DRAWN BY: <i>Hugo.cai</i>	DATE: Mar - 12 - 20
	SHEET:		APPROVED BY:	DATE:	REVISION:
		RELEASE LEVEL:			