

Wyndham 2 features integral armrests.
Shown with optional textured bottom.

Designer Collection Tubs
Model # 6

Wyndham 2

59.25" x 31.25" x 19.125"

GENERAL SPECIFICATIONS:

Material - Acrylic

Installation - Drop-in (cannot be undermounted)

Plumbed Weight - 125 lbs / 57 kg

Soaker Weight - 100 lbs / 45 kg

Average Fill - 34 gal to above jet level

Maximum Fill - 52 gal to overflow

NOTE: Filling this tub to the maximum may require an above average size or dedicated water heater.

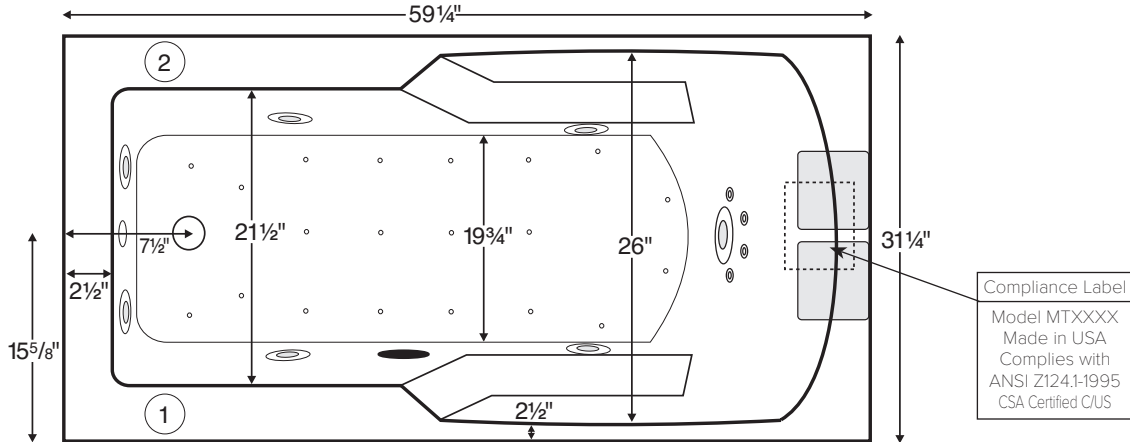

Compliance Label
Model MTXXXX
Made in USA
Complies with
ANSI Z124.1-1995
CSA Certified CUS

Numbered areas on tub deck represent possible locations to install cleaning systems, faucets and other fixtures.
Shown with Air Massage and Ultra Whirlpool Package.

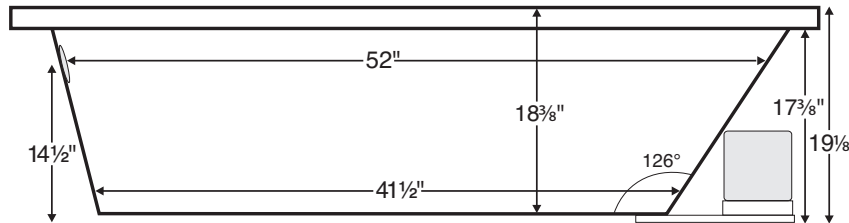

IMPORTANT:
Air baths and tubs with a pre-leveled foam base or frame system add 2-3" to overall tub height.

ELECTRICAL COMPONENTS & SPECIFICATIONS

Required Electrical Service - 110 Volt

Hydrotherapy Package	Components Included	GFCI
Standard Whirlpool	2-bhp pump	1-15 amp
Ultra Whirlpool	2 2-bhp pumps, inline heater	2-20 amp
Air Massage	heated blower	1-15 amp
Air Massage Elite	heated blower, chromatherapy	1-15 amp
Air Massage with Standard Whirlpool	2-bhp pump, heated blower	2-15 amp
Air Massage with Ultra Whirlpool	2 2-bhp pumps, inline heater, heated blower	2-20 amp
Air Massage Elite with Standard Whirlpool	2-bhp pump, heated blower, chromatherapy	2-15 amp
Air Massage Elite with Ultra Whirlpool	2 2-bhp pumps, inline heater, heated blower, chromatherapy	2-20 amp

Electrical requirements may change with the addition of optional therapy components. See specific [option details](#) or [installation information](#).

CSA Certified C/US; ANSI Z124.1 and ANSI 112.19.7.

IMPORTANT ORDERING & INSTALLATION INFORMATION:

- Before ordering or installing, please consider future access to equipment.
- Add proper bedding compound to fully level and support bottom of tub.
- Tubs equipped with an air bath or a pre-leveled foam base are designed to rest on a flat, level subfloor without bedding compound.
- **Overall tub height is increased by approx. 2-3" when tub is equipped with any air bath package or when pre-leveled foam base or frame system is ordered.**
- Radiance placed on airbath floor will affect placement of air jets.
- When ordering Microbubbles, system components will extend beyond the perimeter of tub.
- Please measure tub **on-site** before building tub decking.
- If you are planning to use a glass enclosure, advised MTI when ordering. Relocation of controls may be necessary.
- Suction and control locations may vary.
- Specifications and configurations are subject to change without notice.
- Measurements are $\pm 1/2"$ and are subject to change without notice.
- Measurements herein supersede all others published prior to publication date shown below.













See the [Installation & Operation Manual](#) for Designer Series Air & Whirlpool Tubs for more details.

MTI's Customer Service Department • Monday-Friday 8am-6pm EST • 800-783-8827 or service@mtibaths.com



Packages and Pricing

For more information on any of the following packages, please visit: mtibaths.com/wellness/

Hydrotherapy Packages	Package Contents	Part #	MSRP
 Soaker	Soaking bath - no jets	S6	\$1,340
 Stream Bath	6 side vents, 2 end vents, 1-bhp pump	SM6	\$3,190
 Air Massage	20 air jets, heated air blower, Aromatherapy, pre-leveled foam base (increases overall height 2-3")	AST6	\$4,155
 Air Massage Elite	30 air jets, heated air blower, Aromatherapy, Chromatherapy LED lighting, Spa Mode, pre-leveled foam base (increases overall height 2-3")	AE6	\$5,885
 Stream Bath with Air Massage	6 side vents, 2 end vents, 1-bhp pump, 20 air jets, heated air blower, Aromatherapy, pre-leveled foam base (increases overall height 2-3")	ASTSM6	\$6,005
 Stream Bath with Air Massage Elite	6 side vents, 2 end vents, 1-bhp pump, 30 air jets, heated air blower, Aromatherapy, Chromatherapy LED lighting, Spa Mode, pre-leveled foam base (increases overall height 2-3")	AESM6	\$7,735
 Standard Whirlpool	5 point-massage jets, 2-bhp pump	P6	\$2,780
 Ultra Whirlpool	7 point-massage jets, 4 micro-jets, 3-bhp pump, inline heater, Ozone	P6U	\$4,270
 Air Massage with Standard Whirlpool	5 point-massage jets, 2-bhp pump, 20 air jets, heated air blower, Aromatherapy, pre-leveled foam base (increases overall height 2-3")	AW6	\$5,760
 Air Massage with Ultra Whirlpool	7 point-massage jets, 4 micro-jets, 3-bhp pump, inline heater, 20 air jets, heated air blower, Aromatherapy, Ozone, pre-leveled foam base (increases overall height 2-3")	AU6	\$7,175
 Air Massage Elite with Standard Whirlpool	5 point-massage jets, 2-bhp pump, 30 air jets, heated air blower, Aromatherapy, Chromatherapy LED lighting, Spa Mode, pre-leveled foam base (increases overall height 2-3")	AEAP6	\$7,250
 Air Massage Elite with Ultra Whirlpool	7 point-massage jets, 4 micro-jets, 3-bhp pump, inline heater, 30 air jets, heated air blower, Aromatherapy, Ozone, Chromatherapy LED lighting, Spa Mode, pre-leveled foam base (increases overall height 2-3")	AEAP6U	\$8,580

Lead Time - Soakers, Stream Bath and Whirlpool Packages - 5 business days
Air Baths and Combo Packages - 7 business days

NOTES: • Aromatherapy is eliminated for undermount applications
• Air Baths, Pre-Leveled Foam Base or Frame Systems increase overall height by 2-3".

RECOMMENDED SENSORY THERAPIES

SEE NEXT PAGE FOR AN OVERVIEW OF AVAILABLE OPTIONS.



Chromatherapy
Underwater lighting is provided by digitally controlled LEDs. Different colors are thought to have different therapeutic effects.

LE - \$610



Audiotherapy
Stereo H₂O lets you "feel" the music through the bath water. Available with Bluetooth system or transducers with leads to connect to an external system.

STEREOH202 - \$1,135
STEREOBT - \$1,235



Thermotherapy
Radiance uses integrated radiant heat to warm the backrest for neck, shoulders and back. Inline heaters maintain bath water temperature.

RAD100 - \$1,080
HTISOAK - \$750



Microbubbles
For wellness and beauty, billions of the tiniest air bubbles saturate the water with dissolved oxygen to moisturize and soften the skin. Available for soakers and air baths.

MICRO - \$1,745



Options and Pricing

For more information on any of the following options, please visit: mtibaths.com/wellness/

Premium Options

Electrical requirements may change with the addition of optional therapies. See [installation instructions](#) for more details.

Microbubbles (MICRO) \$1,745

NOTE: Available on Soakers and Air Baths only. Cannot be combined with Inline Heater. System components may extend up to 5" beyond perimeter of the tub.

[See details](#)

Radiance - integrated tub shell heating system (RAD100) \$1,080

Chromatherapy - underwater LED lighting (LE) \$610

Included with some hydrotherapy packages.

Stereo H₂O - audiotherapy

Standard System (STEREOH202) \$1,135

Bluetooth System (STEREOBT) \$1,235

[See details](#)

Standard Options

Standard Colors - White (CWH), Bone (CBN), Biscuit (CBS)

Color Upgrade (COL2) \$500

Please call for availability of special colors.

Quick Ship - reduces lead time (QSPRI) \$380

Please call for availability.

Textured, Slip-Resistant Bottom (TXBTM) \$75

Compliant with ASTM C 1028-07 friction coefficient.

Virtual Spout - high-flow integrated tub filler (FPMJ) \$310

Inline Heater - maintains water temperature

For whirlpools or Stream Bath (HTI) \$545

Uses existing pump

Soaker or Air Baths (HTISOAK) \$750

Includes a recirculating pump

NOTE: Some hydrotherapy packages include an inline heater. Electrical requirements will change with the addition of Inline Heater. See [installation instructions](#) for more details. Cannot be combined with Microbubbles.

Installation Aids

Tile Flange

Factory-Installed on 3 sides - rigid ABS (TFK3) \$190

Field Install Kit - includes rigid ABS & adhesive (TFKNI) \$175

IMPORTANT: Must specify flange location(s) on order of Factory-Installed Flange. Not available with optional Low-Profile Rim.

Pre-Leveled Foam Base (PLFOAM) \$175

For soakers and whirlpools. All airbaths include a pre-leveled foam base.

Pre-Leveled Frame and Foam Base (PLF) \$525

Pre-Leveled Frame and Foam Base with Skirting

[See details and pricing](#)

Accessories & Hardware for All Packages

Drain Kits - other finishes also available [See details and pricing](#)

Toe-Tap with Slim-Line Integrated Overflow \$390

Chrome (SLOT), Brushed Nickel (SLOTBN), Polished Nickel (SLOTPN) or White (SLOTWH)

Toe-Tap with Rectangular Overflow

Chrome (WOTRC) \$285, Brushed Nickel (WOTRBN) \$290
White (WOTRW) \$290

Toe-Tap with Round Overflow

Chrome (WOTTC) \$285, Brushed Nickel (WOTTBN) \$290
Polished Nickel (WOTTPN) \$340

Cable Driven

Chrome (WOCD) \$315, Brushed Nickel (WOCDBN) \$385
Polished Nickel (WOCDPN) \$515
Oil-Rubbed Bronze (WOCDOR) \$515

Lift & Turn

Chrome (WOC) \$125, Brushed Nickel (WOBN) \$225

Grab Bars - 9" Curved, set of 2

Acrylic - Color-Matched (GB) \$300

Metal - Chrome (GBMCC), Brushed Nickel (GBMCBN) \$330

NOTE: Acrylic grab bars available in standard colors only.

Pillows - from \$125 [See details and pricing](#)

Teak Tub Tray \$415

Slatted (TK-TRAY1), Solid (TK-TRAY2)

Teak Bath Mat (TKMAT3018) \$430

Custom sizes also available. Contact MTI for details and pricing.

Accessories & Cleaning Systems for Whirlpool Packages

Trim Kits

For Standard Whirlpool

Chrome (TRC) \$235, Brushed Nickel (TRBN) \$595

For Ultra Whirlpool

Chrome (TRCU) \$320, Brushed Nickel (TRBNU) \$815

Must be ordered at time of purchase. Other finishes available.

Pump Upgrade - 3-bhp (PUMP3) \$245

Additional Jet Options [See details and pricing](#)

Whirlpool Cleaning Systems

Fill-Flush (FFSO) \$590

Simple Touch (FFE) \$710

[See details](#)

Ozonator - bath water purification system (OZONE) \$535

[See details](#)

