

21-HAF.1

Wall Mounted Shower Head

Includes 14" Shower Arm and Flange

Flow Rate: 1.75 GPM

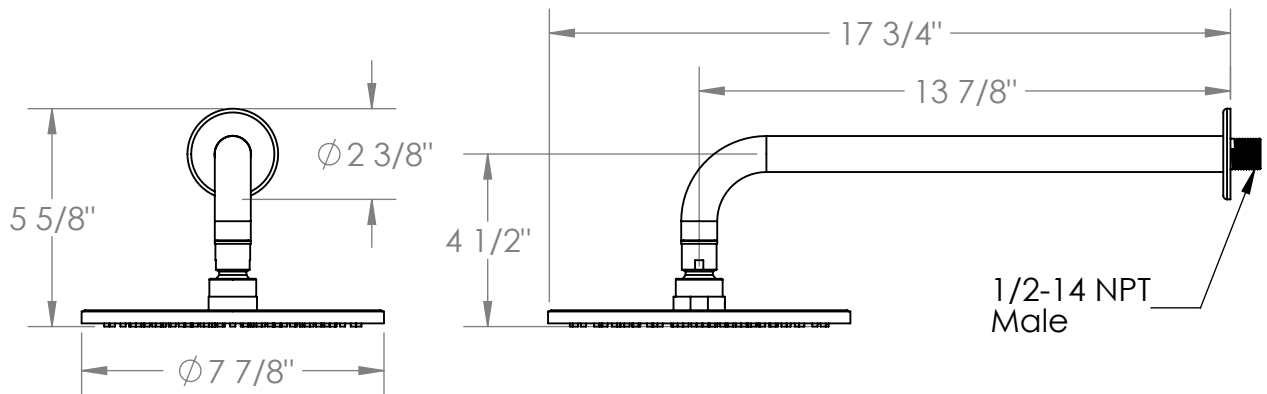

Meets the applicable requirements of ASME A112.18.1-2005/CSA B125.1-05, entitled "Plumbing Supply Fittings"

WATERMARK DESIGNS 3/1/2022

350 Dewitt Ave Brooklyn NY 11207 USA T 718 257 2800 F 718 257 2144 info@watermark-designs.com