

# WATERMARK

BROOKLYN, NEW YORK

## Refinement 19-8.1GB-LT6S

Deck Mounted 5 hole Gooseneck Bath set



- Includes 49" Hose, DS-5079SM
- Some building codes require remote pressure balance valves for anti-scald
- Handshower Flow Rate: 1.75 GPM
- Fits Deck Up to 1 7/8" Thick
- 1/2 Turn Ceramic Cartridge
- All Solid Brass Construction
- Professional Installation Required

Available in all finishes shown on the [Watermark Designs website](#)

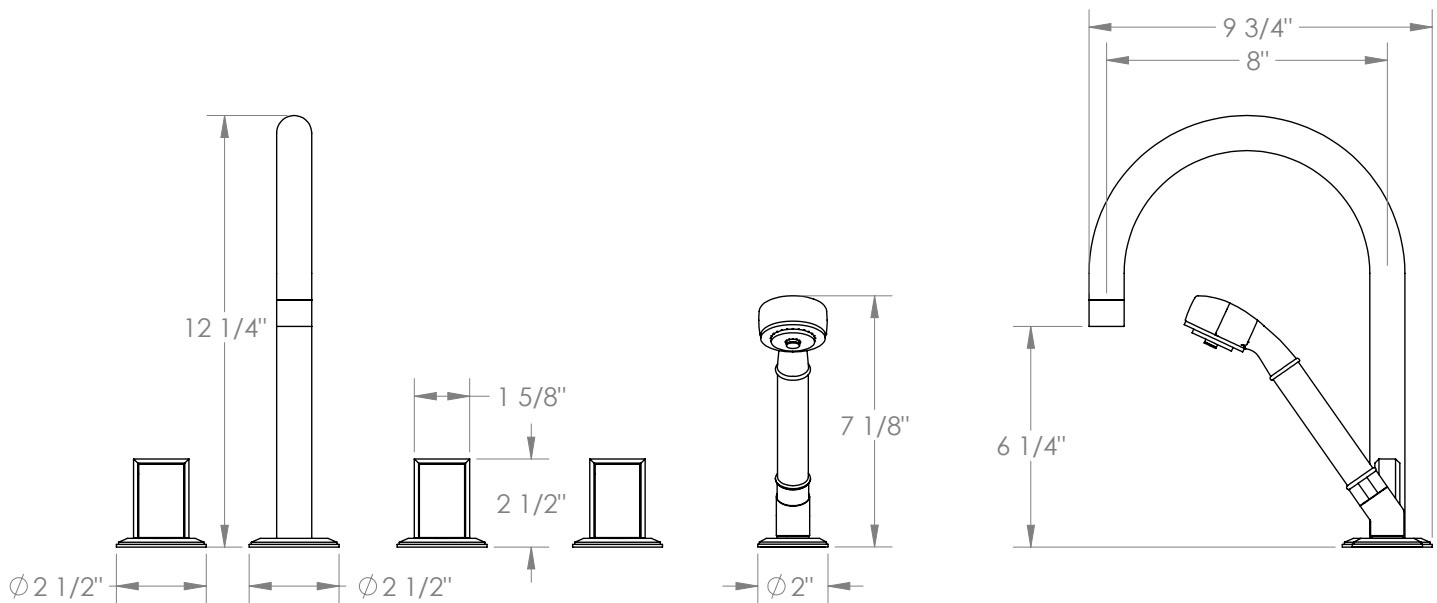

Meets the applicable requirements of ASME A112.18.1/CSA B125.1, entitled "Plumbing Supply Fittings".

Watermark Designs reserves the right to make revisions without notice to product specifications. All product dimensions are nominal.

Updated: 02/2026

350 Dewitt Ave. Brooklyn, NY 11207 USA | T: 1 718 257 2800 | F: 1 718 257 2144 | [customerservice@watermark-designs.com](mailto:customerservice@watermark-designs.com)