

# WATERMARK

BROOKLYN, NEW YORK



## Refinement 19-1.3-LT6S Deck Mounted 2 Hole Extended Lavatory Set

- Includes MPU5 soft touch drain with overflow
- Flow Rate: 1.2 GPM
- Fits Deck Up to 1 7/8" Thick
- 1/2 Turn Ceramic Cartridge
- All Lead-Free Brass Construction
- Professional Installation Required

Available in all finishes shown on the [Watermark Designs website](#)

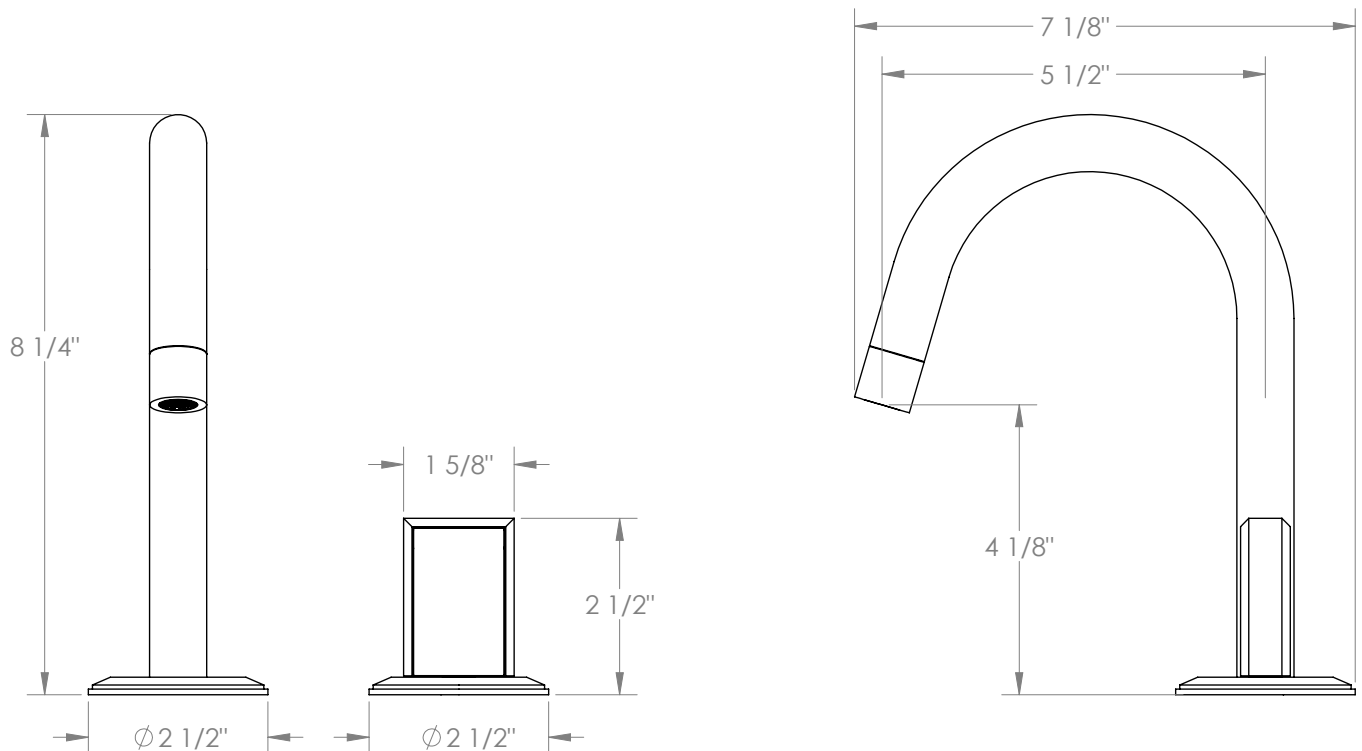

Meets the applicable requirements of ASME A112.18.1/CSA B125.1, entitled "Plumbing Supply Fittings".

Watermark Designs reserves the right to make revisions without notice to product specifications. All product dimensions are nominal.

Updated: 02/2026

350 Dewitt Ave. Brooklyn, NY 11207 USA | T: 1 718 257 2800 | F: 1 718 257 2144 | [customerservice@watermark-designs.com](mailto:customerservice@watermark-designs.com)