

WATERMARK

BROOKLYN, NEW YORK

Refinement 19-1.2M-LT6S

Wall Mounted 2 Hole Lavatory Set



- Order drain separately (See Ancillaries)
- Requires concealed rough SS-SHV1.2
- Flow Rate: 1.2 GPM
- 1/2 Turn Ceramic Cartridge
- All Lead-Free Brass Construction
- Professional Installation Required

Available in all finishes shown on the [Watermark Designs website](#)

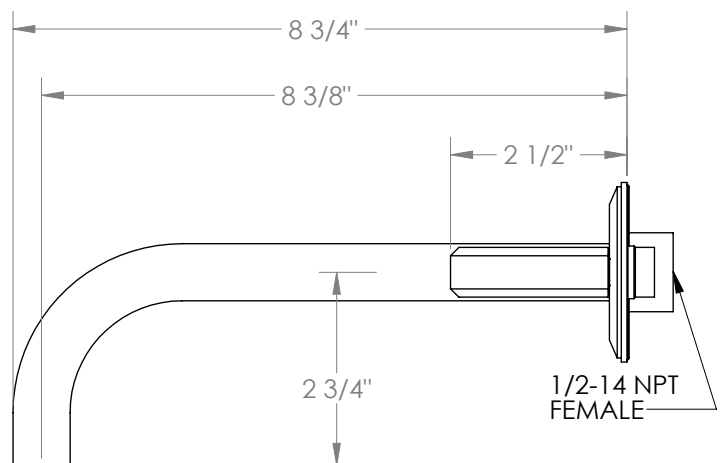
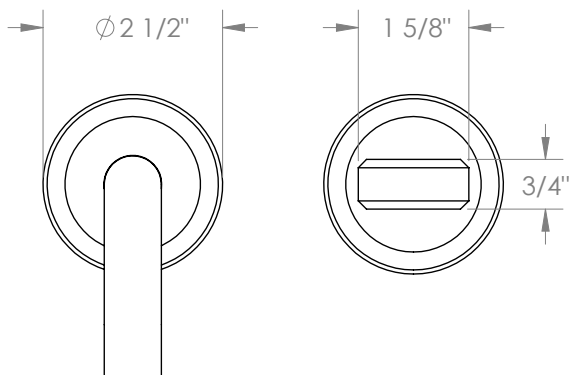

Meets the applicable requirements of ASME A112.18.1/CSA B125.1, entitled "Plumbing Supply Fittings".

Watermark Designs reserves the right to make revisions without notice to product specifications. All product dimensions are nominal.

Updated: 02/2026

350 Dewitt Ave. Brooklyn, NY 11207 USA | T: 1 718 257 2800 | F: 1 718 257 2144 | customerservice@watermark-designs.com