

# BUSTER+PUNCH

LONDON

[ product. ]

## ELECTRICITY / 1G-4G PLATE / METAL

[ with. **INFILLS.** ]

[ detail. **COIN SCREW.** ]

[ born. **LONDON.** ]

[ region. **NORTH AMERICA.** ]

Decorative cover plate sets in a variety of quality finishes, complete with flush fitting infills. Designed to be completed with range of module inserts to suit a broad spectrum of requirements for lighting control, power supply and device charging. Always finish with our signature details kit & coin screws.

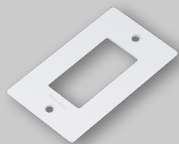

[ finish. **WHITE.** ]

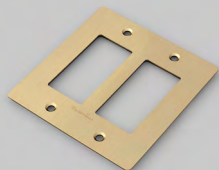

[ finish. **BRASS.** ]

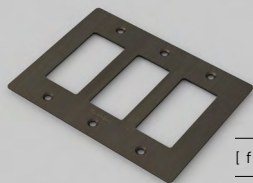

[ finish. **SMOKED BRONZE.** ]



[ finish. **BLACK.** ]

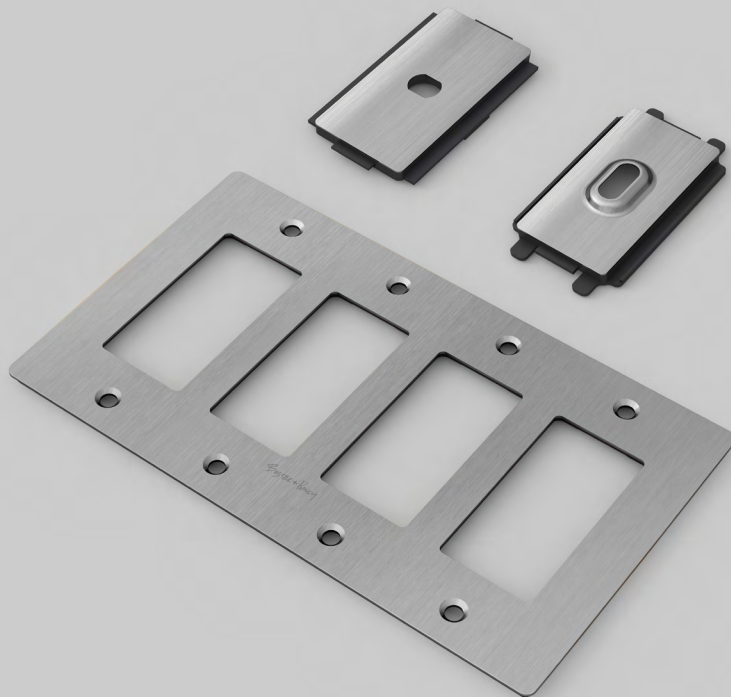

[ finish. **STEEL.** ]

---

[ type. **1G PLATE / METAL.** ]

---

[ info. **MEASUREMENTS.** ]

---

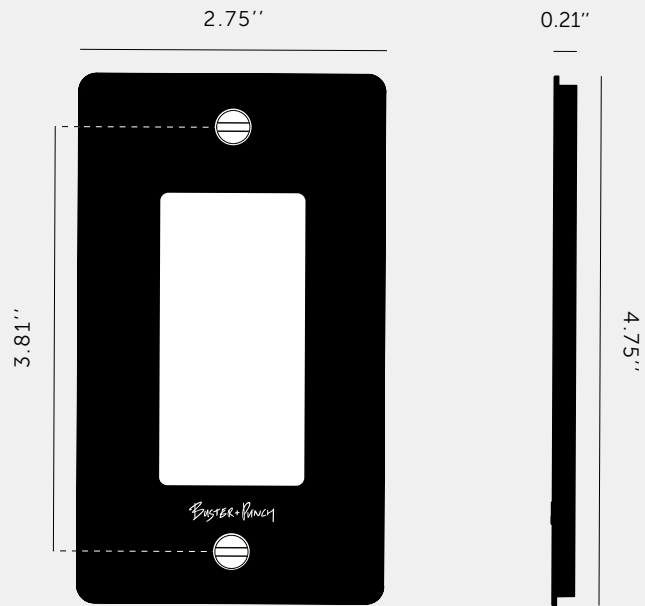

---

[ info. **SPECIFICATIONS.** ]

---

Our Metal Electricity range has solid stainless steel plates, in our signature white, steel, brass, smoked bronze and black finishes.

Style: 1G metal plate + infills.

For use with class 1 modules only / Must be earthed.

Recommended Back Box:

Standard flush mounted 1G back box. See dimensions of chosen module(s) for required back box depth.





---

[ info. **FINISH & SKU NUMBERS.** ]

---

[ finish. ]

[ US. ]

 White	NPL-023061
 Steel	NPL-07292
 Brass	NPL-05289
 Smoked Bronze	NPL-09291
 Black	NPL-053060

---

[ info. **CARE INSTRUCTIONS.** ]

---

Wipe with damp cloth with no loose hairs, avoid using any chemicals. All finishes are prone to aging.

---

[ info. **CERTIFICATION.** ]

---

Plates: Underwriters Laboratories cULus listed for use throughout North America: E507052.

---

[ please. **NOTE.** ]

---

DISCLAIMER: Always consult a trade professional when installing this plate. Buster + Punch is not responsible for the usage or feasibility of installation requirements. This product is not suitable for damp or wet environments.

---

[ type. **2G PLATE / METAL.** ]

---

[ info. **MEASUREMENTS.** ]

---

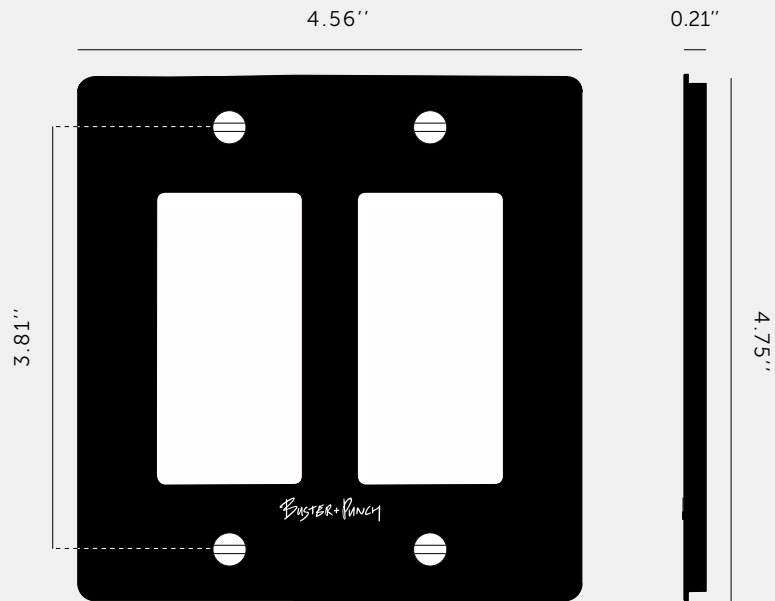

---

[ info. **SPECIFICATIONS.** ]

---

Our Metal Electricity range has solid stainless steel plates, in our signature white, steel, brass, smoked bronze and black finishes.

Style: 2G metal plate + infills.

For use with class 1 modules only / Must be earthed.

Recommended back box:

Standard flush mounted 2G back box. See dimensions of chosen module(s) for required back box depth.

---

[ info. **FINISH & SKU NUMBERS.** ]

---

[ finish. ]

[ US. ]

White	NPL-143064
Steel	NPL-07297
Brass	NPL-05294
Smoked Bronze	NPL-09296
Black	NPL-023063

---

[ info. **CARE INSTRUCTIONS.** ]

---

Wipe with damp cloth with no loose hairs, avoid using any chemicals. All finishes are prone to aging.

---

[ info. **CERTIFICATION.** ]

---

Plates: Underwriters Laboratories cULus listed for use throughout North America: E507052.

---

[ please. **NOTE.** ]

---

DISCLAIMER: Always consult a trade professional when installing this plate. Buster + Punch is not responsible for the usage or feasibility of installation requirements. This product is not suitable for damp or wet environments.

---

[ type. **3G PLATE / METAL.** ]

---

[ info. **MEASUREMENTS.** ]

---

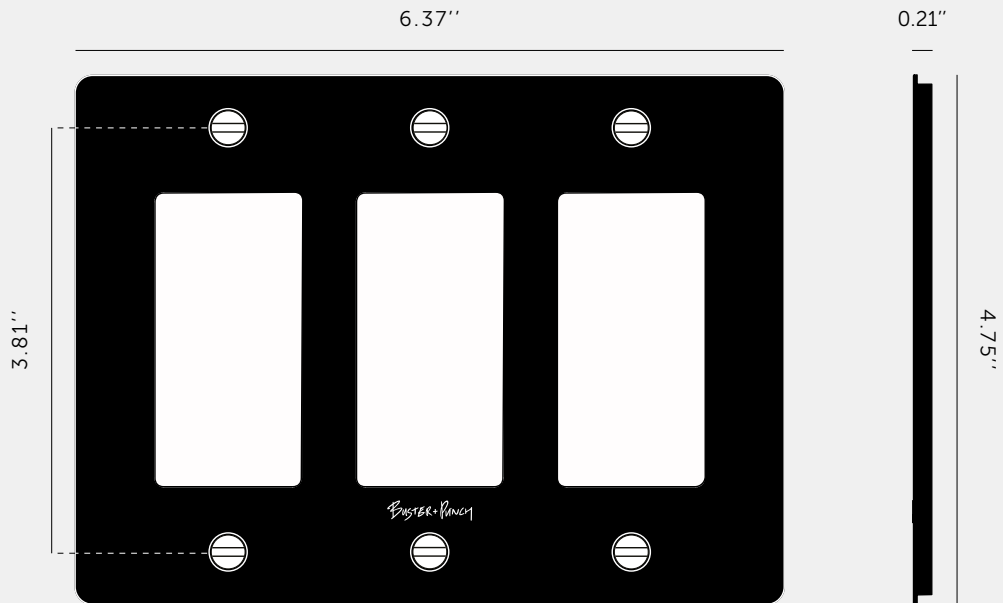

---

[ info. **SPECIFICATIONS.** ]

---

Our Metal Electricity range has solid stainless steel plates, in our signature white, steel, brass, smoked bronze and black finishes.

Style: 3G metal plate + infills.

For use with class 1 modules only / Must be earthed

Recommended back box:

Standard flush mounted 3G back box. See dimensions of chosen module(s) for required back box depth.

---

[ info. **FINISH & SKU NUMBERS.** ]

---

[ finish. ]

[ US. ]

● White	NPL-143067
● Steel	NPL-07302
● Brass	NPL-05299
● Smoked Bronze	NPL-09301
● Black	NPL-023066

---

[ info. **CARE INSTRUCTIONS.** ]

---

Wipe with damp cloth with no loose hairs, avoid using any chemicals. All finishes are prone to aging.

---

[ info. **CERTIFICATION.** ]

---

Plates: Underwriters Laboratories cULus listed for use throughout North America: E507052

---

[ please. **NOTE.** ]

---

DISCLAIMER: Always consult a trade professional when installing this plate. Buster + Punch is not responsible for the usage or feasibility of installation requirements. This product is not suitable for damp or wet environments.

[ type. **4G PLATE / METAL.** ]

[ info. **MEASUREMENTS.** ]

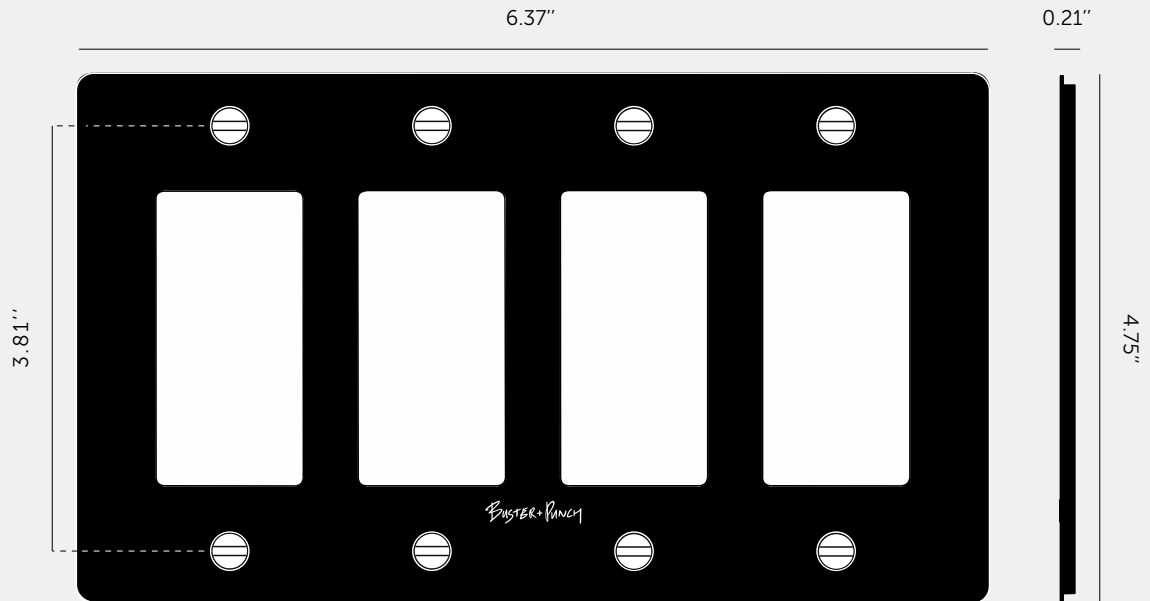

[ info. **SPECIFICATIONS.** ]

Our Metal Electricity range has solid stainless steel plates, in our signature white, steel, brass, smoked bronze and black finishes.

Style: 4G metal plate + infills.

For use with class 1 modules only / Must be earthed.

Recommended back box:

Standard flush mounted 4G back box. See dimensions of chosen module(s) for required back box depth.

[ info. **FINISH & SKU NUMBERS.** ]

[ finish. ]

[ US. ]

White	NPL-143070
Steel	NPL-07307
Brass	NPL-05304
Smoked Bronze	NPL-09306
Black	NPL-023069

[ info. **CARE INSTRUCTIONS.** ]

Wipe with damp cloth with no loose hairs, avoid using any chemicals. All finishes are prone to aging.

[ info. **CERTIFICATION.** ]

Plates: Underwriters Laboratories cULus listed for use throughout North America: E507052.

[ please. **NOTE.** ]

DISCLAIMER: Always consult a trade professional when installing this plate. Buster + Punch is not responsible for the usage or feasibility of installation requirements. This product is not suitable for damp or wet environments.

## **TOGGLE MODULE / STANDARD**

---

**ACTION: TOGGLE MODULE**

---

**RANGE: ELECTRICITY MODULES**

---

Style: On / Off Toggle Switch

Input: 120 - 277VAC / 60Hz

Load: 15A

Switching: single circuit or 3-way circuits

This toggle module is compatible with our detail kits. Toggle modules from other suppliers are not compatible with our detail kits

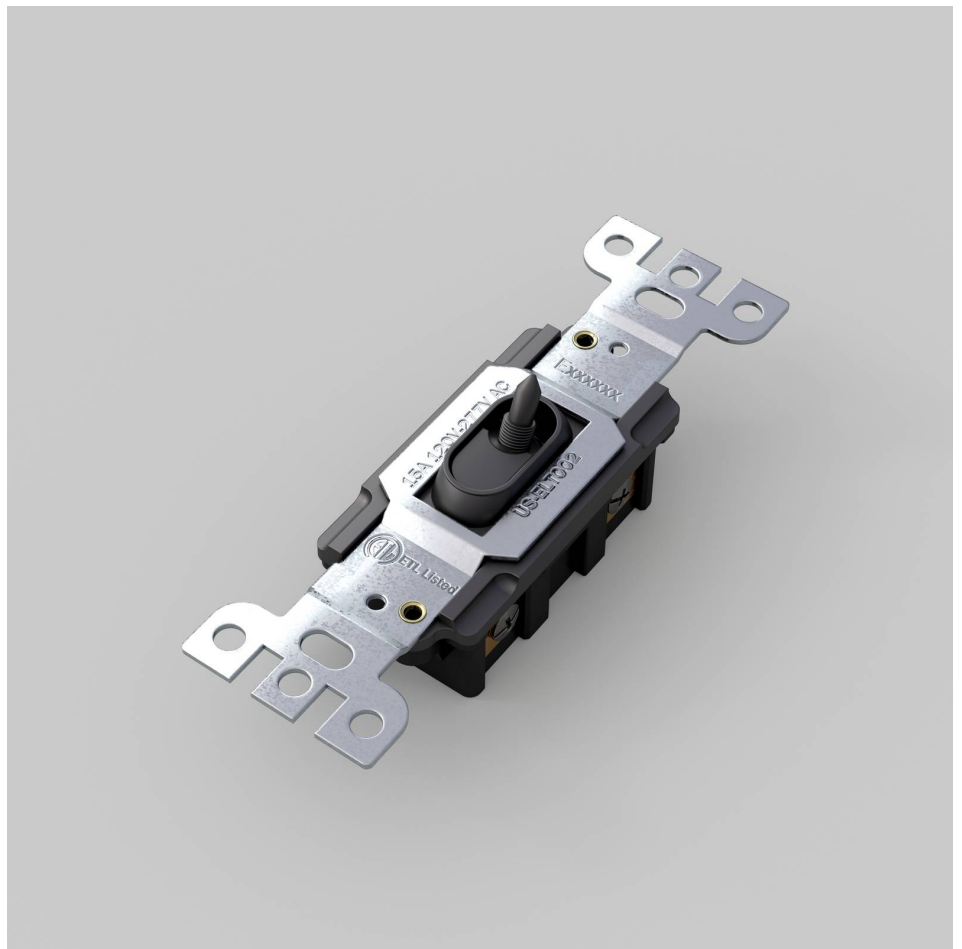

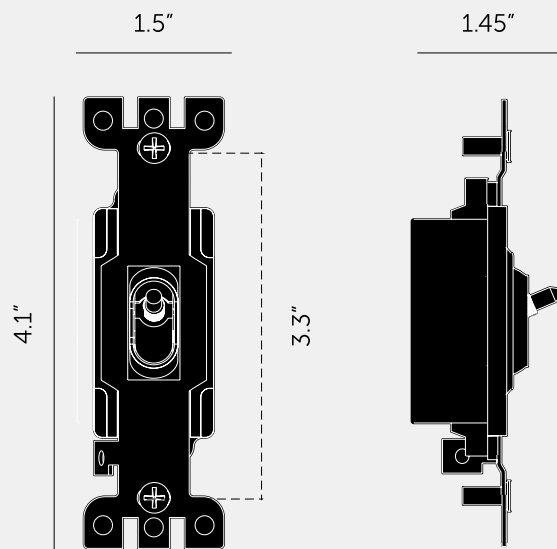

---

#### SPECIFICATIONS

---

Style: On / Off Toggle Switch  
Input: 120 - 277VAC / 60Hz  
Load: 15A  
Switching: 3 way (max 2 per circuit)  
Certification: cETLus 5005703  
Compatibility: 3-Way & 4-way switches.  
Not compatible with retractable switches, motors, fans or other inductive loads.  
Testing Includes:  
Overload - 125 cycles @ 150% max load  
Endurance - 10,000 cycles @ 100% max load  
Dielectric Voltage Withstand - 1500V

---

#### FINISH & SKU NUMBERS

---

sku:	finish:	size:
NTM-01384	● black	1G

---

#### CARE INSTRUCTIONS

---

Wipe with a dry lint free cloth with no loose hairs, avoid using any chemicals. Please note that finishes may age naturally with time and regular use.

---

#### INCLUDED

---

1 x Toggle Module

---

#### PLEASE NOTE

---

DISCLAIMER: Always consult a trade professional when installing this product. Buster + Punch is not responsible for the usage or feasibility of installation requirements. This product is not suitable for damp or wet environments.

**DETAIL KIT /  
TOGGLE / CROSS**

---

**ACTION: DETAIL KIT**

---

**KNURL: CROSS**

---

**RANGE: DETAIL KIT**

---

A toggle switch detail kit made from solid metal. To be teamed up with our toggle modules and wall plates to complete your custom electricity product.



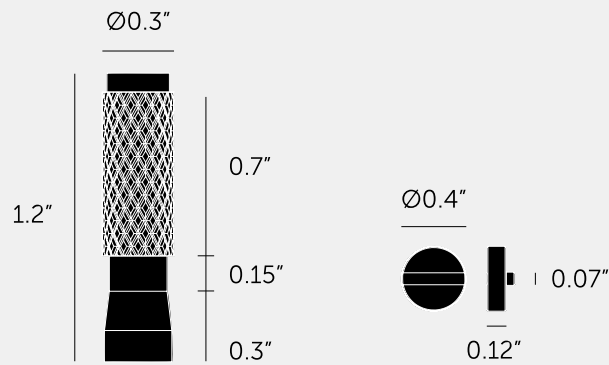

---

#### SPECIFICATIONS

---

A toggle detail kit with coin cap details for use with Buster + Punch switch plates and toggle modules.

---

#### INCLUDED

---

1 x Toggle Detail Kit

---

#### FINISH & SKU NUMBERS

---

sku:	finish:	size:
NTK-02324	● black	1G
NTK-05323	● brass	1G
NTK-09327	● smoked bronze	1G
NTK-07330	● steel	1G
NTK-14332	● white	1G

---

#### PLEASE NOTE

---

DISCLAIMER: Always consult a trade professional when installing this product. Buster + Punch is not responsible for the usage or feasibility of installation requirements. This product is not suitable for damp or wet environments.

---

#### CARE INSTRUCTIONS

---

Wipe with a dry lint free cloth with no loose hairs, avoid using any chemicals. Please note that finishes may age naturally with time and regular use.