

Features

- Modular Cabinet - combine multiple cabinets, lighting, or mirrors
- All cabinets are non-handed/reversible
- Mirrored interior with 3 adjustable, cantilevered glass shelves
- Cantilever shelving adjustable in 1" increments
- Includes installation hardware for recess mounting
- Can be recessed or surface mounted (surface mounting kit required)

Optional Features & Upgrades

- PORTRAY Quick Caddy (QUICKCADDY)
 - PORTRAY Electric Upgrade (P2ELECTRIC)
 - PORTRAY Sliding Magnification Mirror available for 16", 20", and 24" widths*
 - Blum 110° slow close hinges
 - Polished edge or 3/4" beveled front mirror
 - Modular design with multiple installation options (See options below).
 - Other widths/heights available ranging 12" to 24" wide, 20" to 72" high
 - Glass Bins (GLASSBIN3.25, GLASSBIN5.25, GLASSBIN8.5)
- * This accessory cannot be added post-sale.

Construction

- Rust free Satin anodized aluminum construction
- Blum hinges standard
- 3 mirror design - rear of cabinet and both sides of door

Codes/Standards Applicable

- Electric Option Models are ETL certified to:
 - UL 962
 - CSA Standard C22.2 No. 68

Dimensions

Width: 23-1/4" (591 mm)
 Height: 30" (762 mm)
 Depth: 4-5/8" (117 mm) When surface mounted
 7/8" (22 mm) When recessed

Installation Options

Recessed Mount - Rough Opening - 22-1/2" W x 29-1/4" H x 4" D (572 mm W x 743 mm H x 102 mm D)

Surface Mount (Single Cabinet) - Reference Surface Mount Kit when ordering (P2SMKIT)

Pairs with Modular mirrors

Gangs to PL PORTRAY Series Cabinet - Reference PL PORTRAY Ganging Kit when ordering (P2RMGKIT, P2SM-GKIT)

Gangs to Lighting* - Reference Ganging kit for the particular light option when ordering.

* Compatible with Vesper, InLine, Profiles, M Series, PL Series, AiO Cabinet, Vitality Cabinet

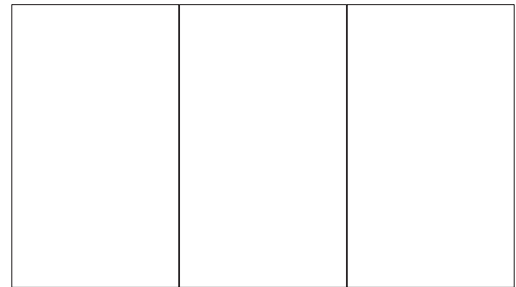
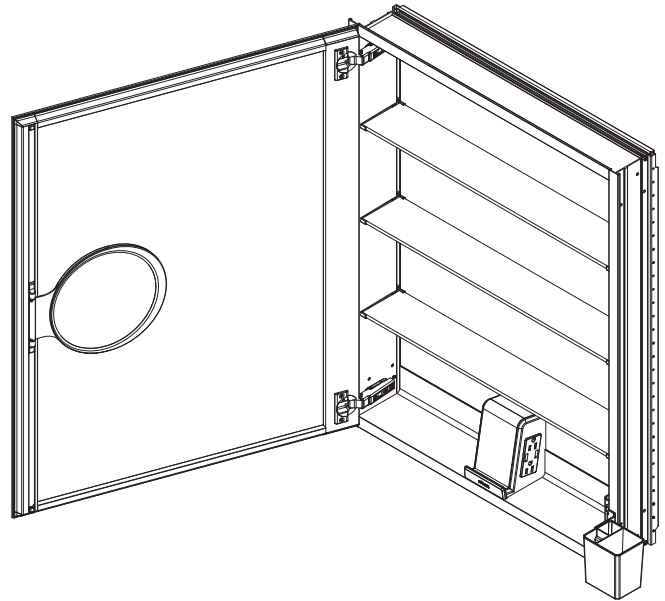

Ganging Cabinet-to-Cabinet Arrangement

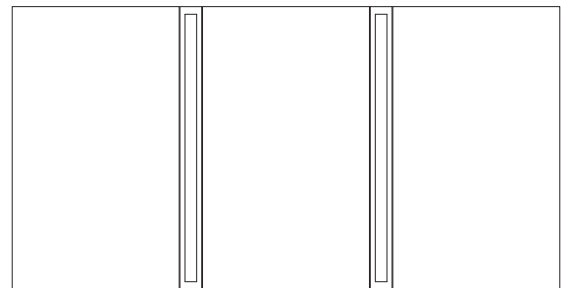

Ganging Cabinet-to-Lights Arrangement

Model Number Key

PL PORTRAY Series	Width	Height	Depth	Mirror Edge Style	Upgrade Option	
P2C	24	30	D4	FP = Polished Edge	BA = No Upgrade	FS = Storage Upgrade
				FB = Bevel Edge	SC = Slow Close Upgrade	TU = Electric Upgrade
					MM = Magnification Mirror Upgrade	FT = Storage and Electric Upgrade

Electrical System

- 120 VAC 60HZ 20A
- Field wire location as shown in drawing
- 1/2" conduit (Ø 7/8" actual) electrical knockout location shown below

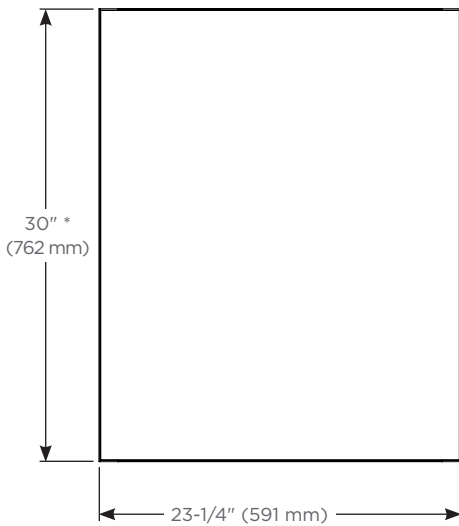
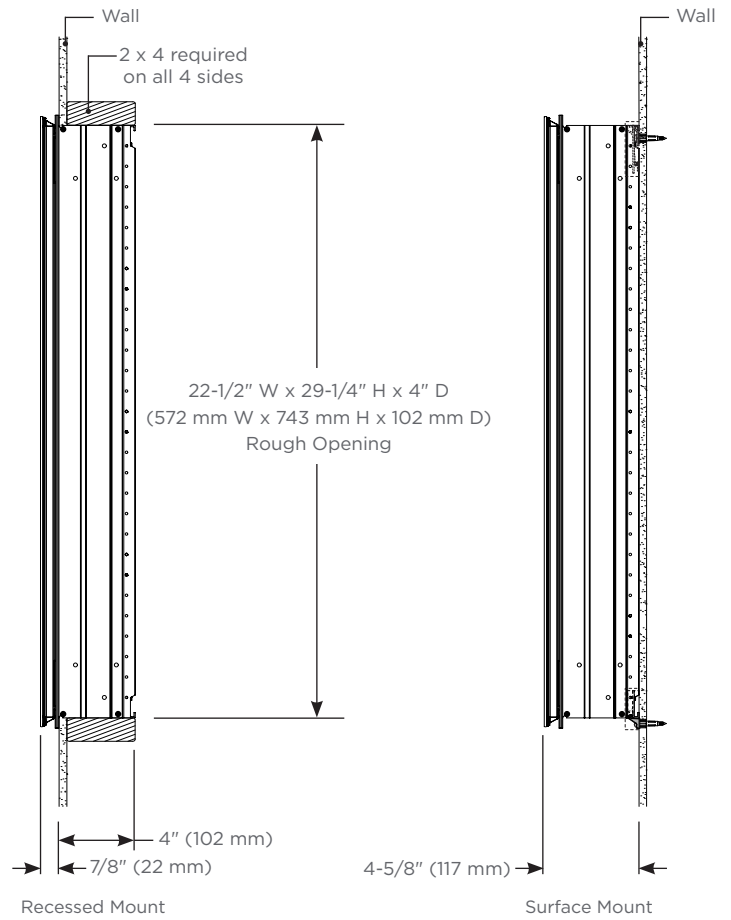

Cabinet Dimensions

*Door is 1/8" (3 mm) smaller than cabinet

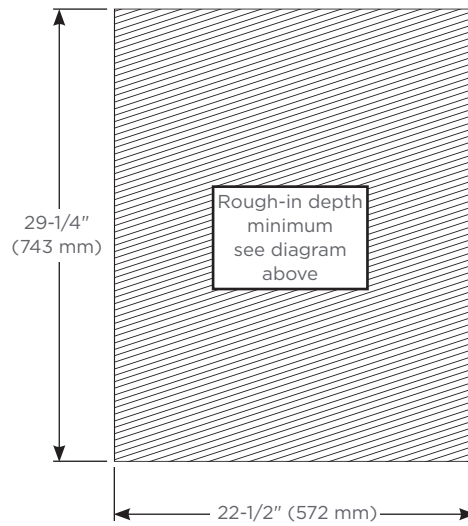

Rough-in Dimensions

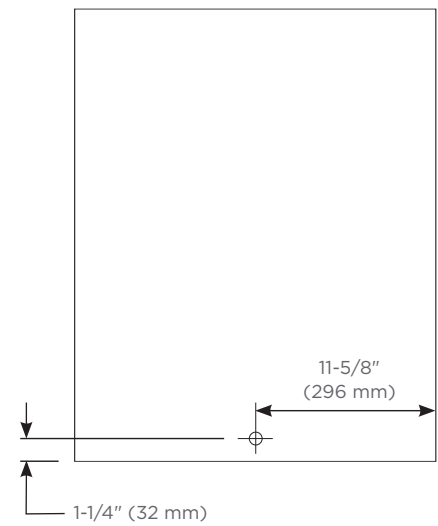

Back of Cabinet - Wire Access Location

Vesper™ Outline Light GLB30ULS - Specification Sheet

Features

- Seamless and flush aesthetic
- Modular lighting can be ganged with M Series/PL Series Cabinets
- Will operate in high humidity or damp spaces
- Thinner profile is ideal for urban spaces for ease of installation
- Warm, relaxing tones (3000K)
- Light provides ambient lighting for a room
- Dimmable LED using a standard residential dimmer that works with your home's existing wiring
- Energy efficient LED's with an estimated life of 53,000 hours:

Kelvin	3000
CRI	90+
R9 Value	60+
Lumens	440

Construction

- Rust-free anodized aluminum and glass construction
- Anodized aluminum back frame
- Quality polished edge mirror
- Diffuser built into the product
- Fully encased lighting construction eliminating exposed LEDs and electrical components
- Wired internally - Front access serviceability

Codes/Standards Applicable

- ETL certified (damp locations) to:
 - UL 1598
 - CSA C22.2 No. 250.0

Dimensions

Height: 30" (762 mm)
 Width: 2-3/4" (70 mm)
 Depth: 4-5/8" (117 mm) When surface mounted
 15/16" (24 mm) When recessed
 Net Weight: 6 - 9 lbs.

Accessories

- Ganging Kit (MGKIT)
- Surface-Mount Kit (MSMK__D_P)
- Semi-Recess Mount Kit (MSMK__D8SRP)

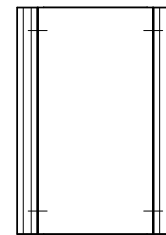
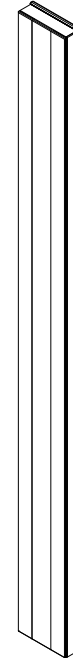

Typical Ganged Arrangement

Note: This fixture adds 2-3/4" per light or 5-1/2" per pair to the overall rough-in width.

Model Number Key

Product Line	Width	Height	Light Design	Light Type	Qty of Lights	Main Body Color	Color Temp	Engine Type
GL = Vesper Light	B = 2-3/4"	30 = 30"	U = Outline	L = LED	S = Single Light	S = Silver	3 = 3000K	D = Dimmable

Installation

- Sold as a single unit (not as pairs)
- Fixture adds 2-3/4" per light (5-1/2" pair) to the overall rough-in width
- Vesper Lighting comes with hardware to mount to one side of a cabinet
- If ganging more than one cabinet, a MGKIT is required
- Can be surface-mounted with 4" depth (D4), 6" depth (D6) and 8" depth (D8) cabinets (D4, D6 and D8 surface-mount kit required). Can be semi-recessed with 6" (D6) and 8" depth (D8) cabinets (D6 and D8 semi-recessed kit required) and fully recessed with 4" depth (D4), 6" depth (D6) and 8" depth (D8) cabinets

Electrical System

- Operates on 120 volts AC and 1.6A max (3000K) per fixture
- Recommended dimmer for fixture: Lutron C.L Dimmers or Caseta Wireless.
- (US) ETL and (Can) ETL Listed for Damp Locations
- Field wire location as shown in drawing

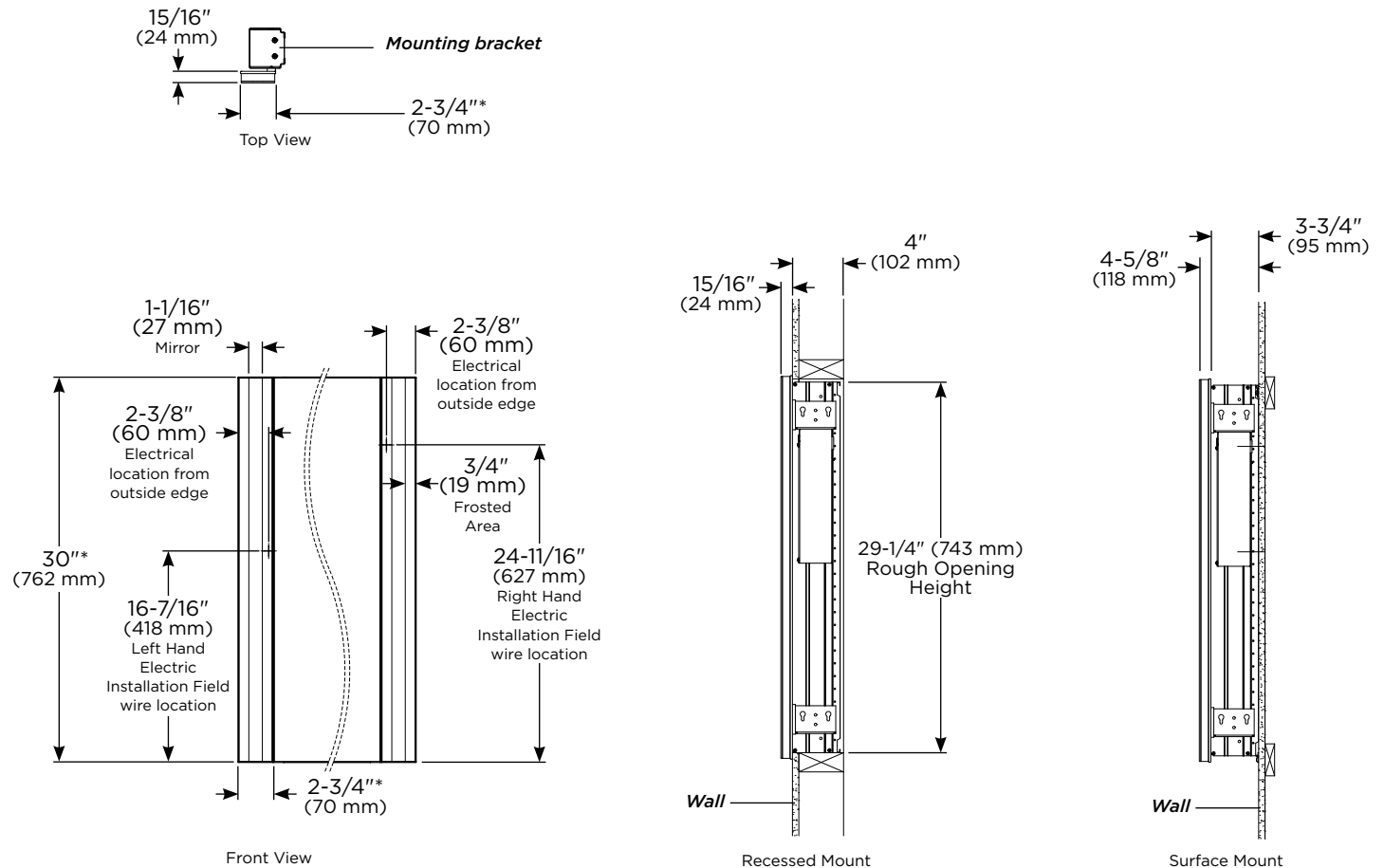

*Lens dimensions are 1/8" (3 mm) smaller than light body