

**36" CROWLEY DOUBLE
BOWL FARMER SINK**

Cat. No
FSSDB2502-SS

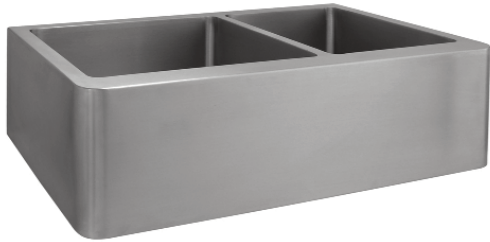

W: 36"
D: 20"
H: 10-1/2"

Features:

- ▶ Solid 16 gauge, 304 grade metal construction
- ▶ Tight radius corners
- ▶ Easy maintenance with matte finish
- ▶ Rim width is 1-1/2"
- ▶ Drain is 3-1/2"
- ▶ 60/40 offset

Compliance Certification
Meets or exceeds the following
specifications: ASME
A112.19.3-2001 for Stainless Steel.

***Please do NOT cut hole without
template or actual product.**

Interior Dimensions:

Large

Basin Interior: 19" W x 16" D
Basin Depth: 10"

Small

Basin Interior: 13" W x 16" D
Basin Depth: 10"

Front

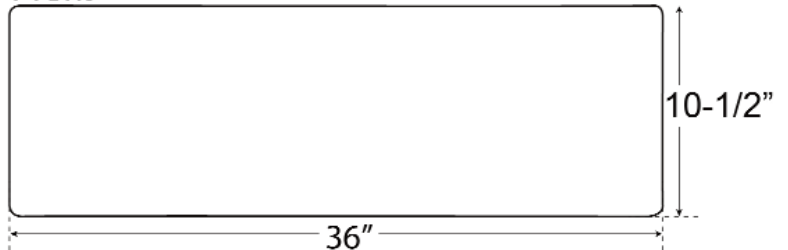

Top

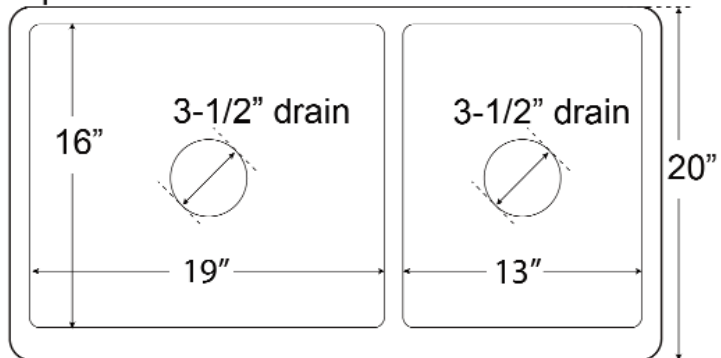

Dimensions of fixture are nominal and may vary within the range of tolerances established by ANSI Standard A112.19.2. Dimensions and specifications subject to change without notice.