

DAYTONA FOR KIRA

- WALL HUNG option is also available for this model.
Vanity height without legs is 25.3".
- Quality metal BLUM (or BLUM equivalent) soft-closing hinges and/or drawer hardware are included.

KIRA CERAMIC SINK

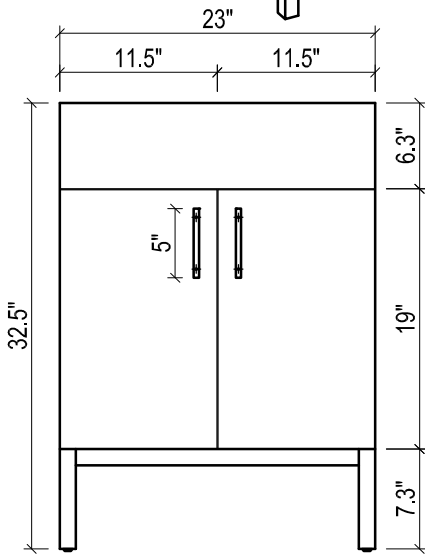
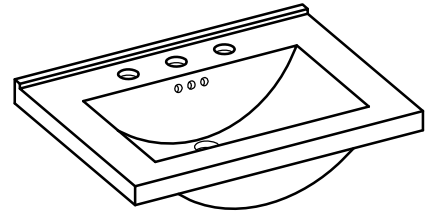
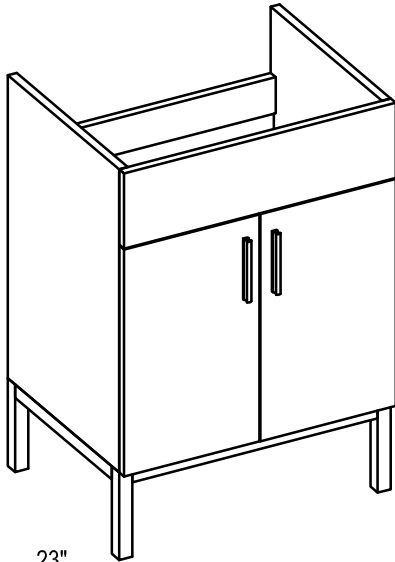

FRONT VIEW

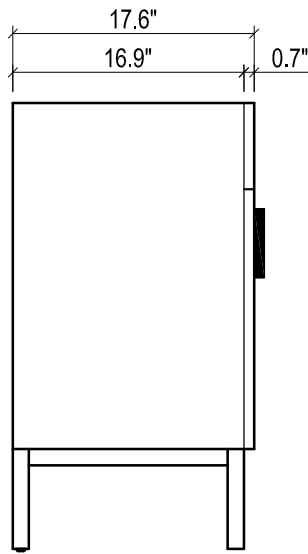

SIDE VIEW

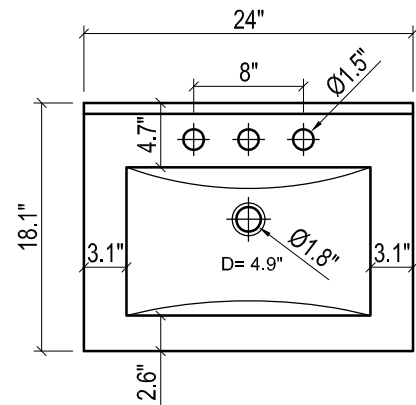

TOP VIEW

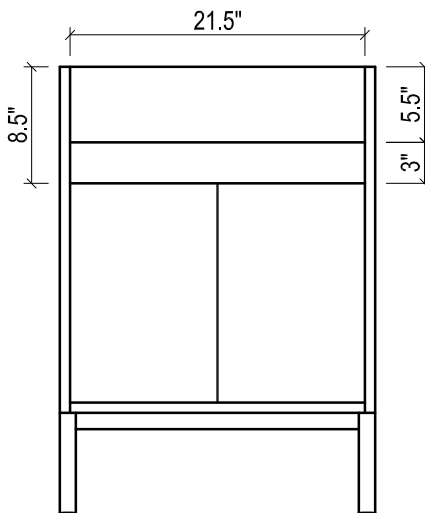

BACK VIEW

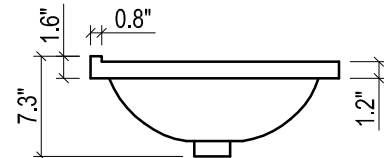

SIDE VIEW

DAYTONA FOR TRIBECA

- WALL HUNG option is also available for this model.
Vanity height without legs is 25.3".
- Quality metal BLUM (or BLUM equivalent) soft-closing hinges and/or drawer hardware are included.

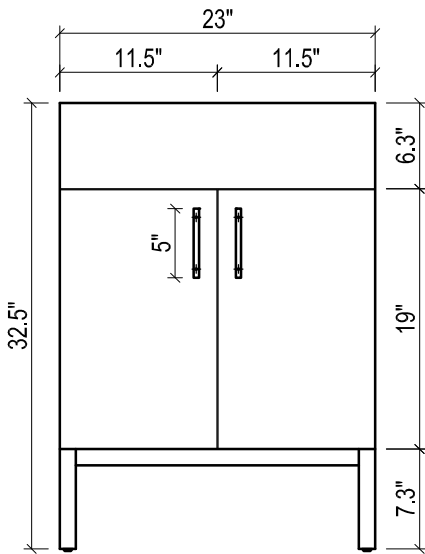
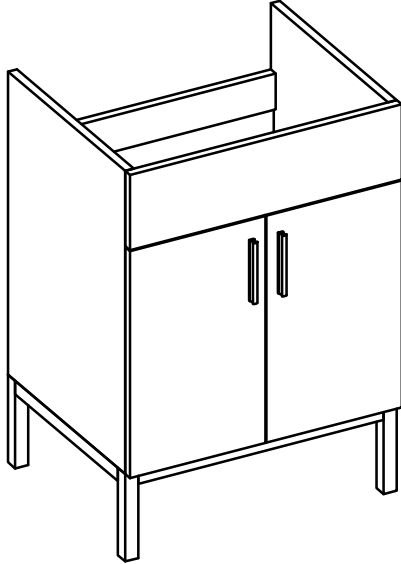

FRONT VIEW

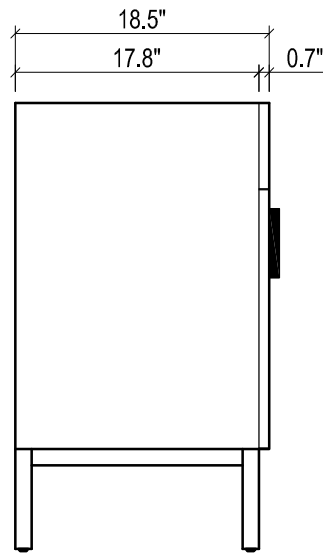

SIDE VIEW

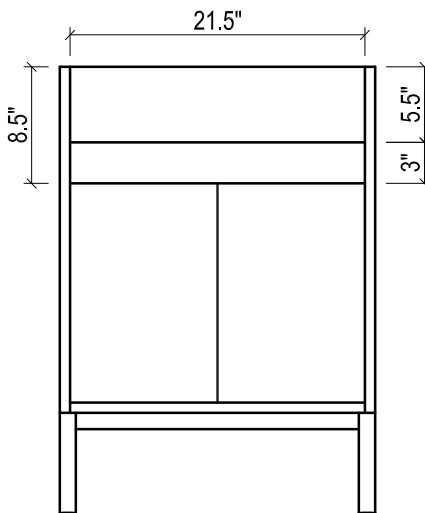

BACK VIEW

TRIBECA CERAMIC SINK

(available in 1 hole or 8" faucet drills)

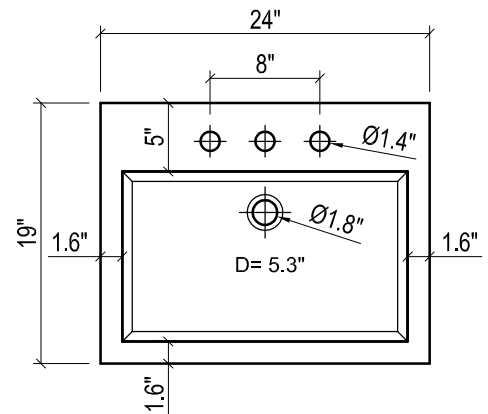
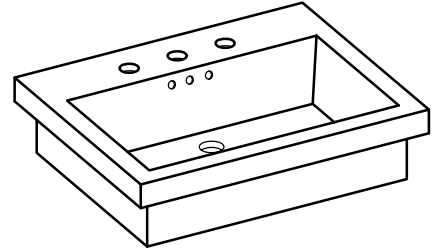

TOP VIEW

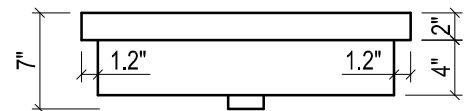

FRONT VIEW

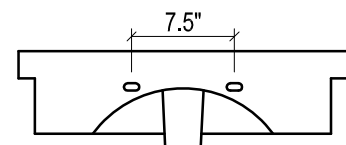

BACK VIEW

DAYTONA FOR VENICE

- WALL HUNG option is also available for this model.
Vanity height without legs is 25.3".
- Quality metal BLUM (or BLUM equivalent) soft-closing hinges and/or drawer hardware are included.

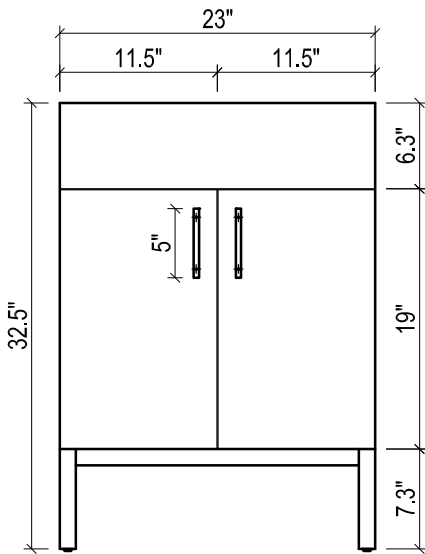
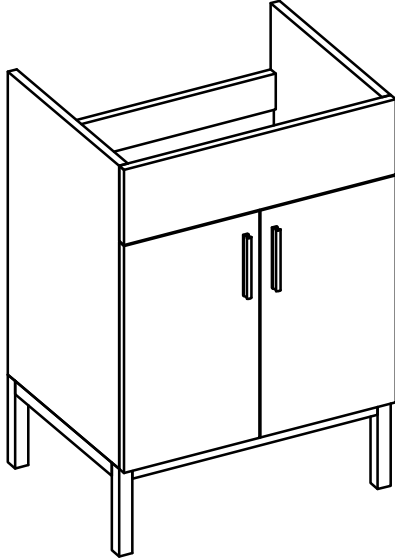

FRONT VIEW

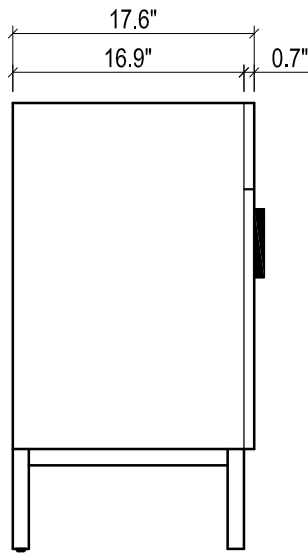

SIDE VIEW

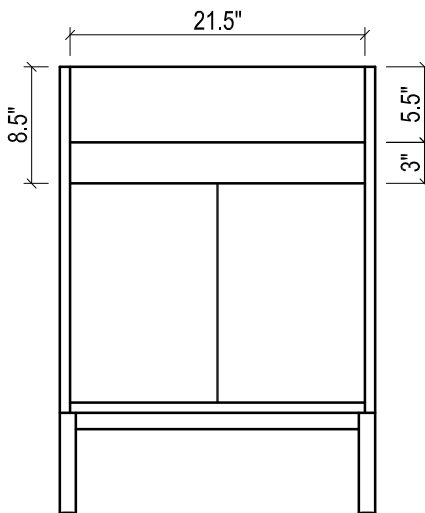

BACK VIEW

VENICE CERAMIC SINK

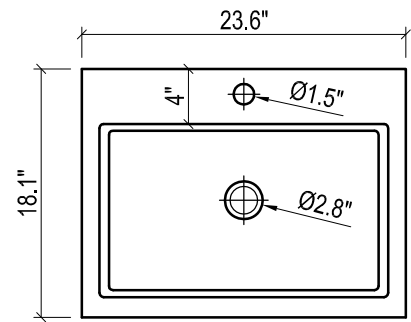
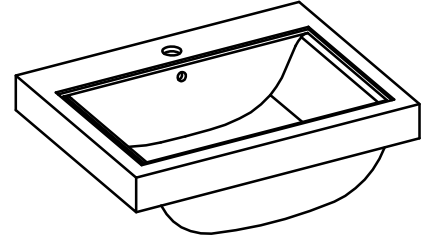

TOP VIEW

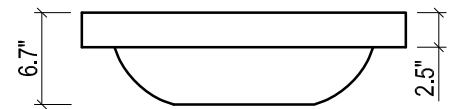

FRONT VIEW

DAYTONA FOR VILLA

- WALL HUNG option is also available for this model.
Vanity height without legs is 25.3".
- Quality metal BLUM (or BLUM equivalent) soft-closing hinges and/or drawer hardware are included.

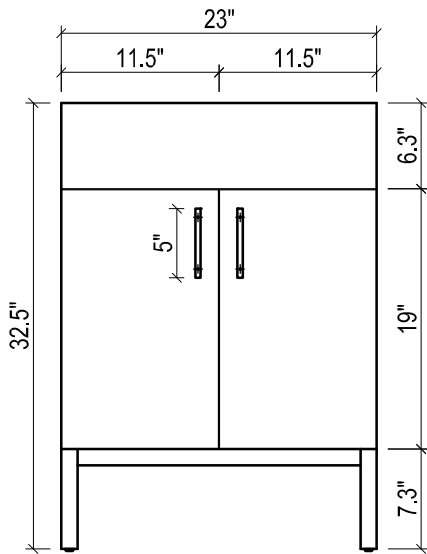
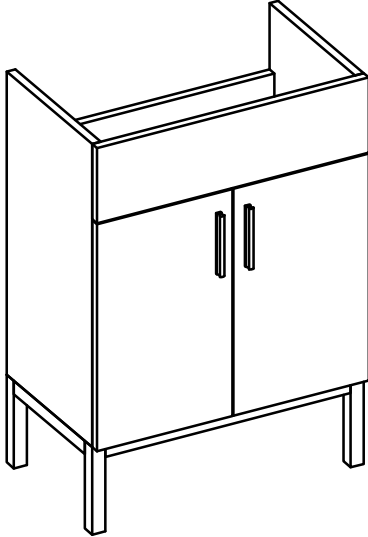

FRONT VIEW

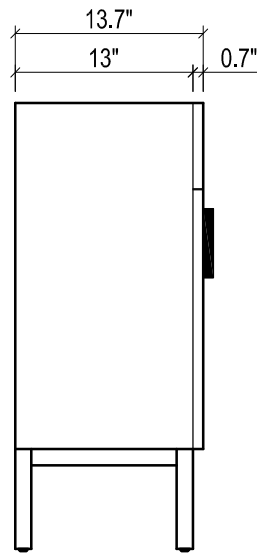

SIDE VIEW

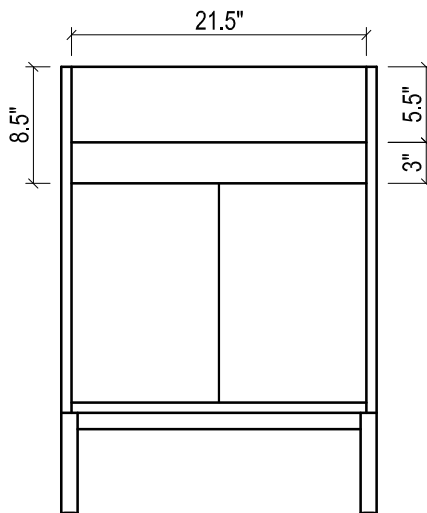

BACK VIEW

VILLA CERAMIC SINK

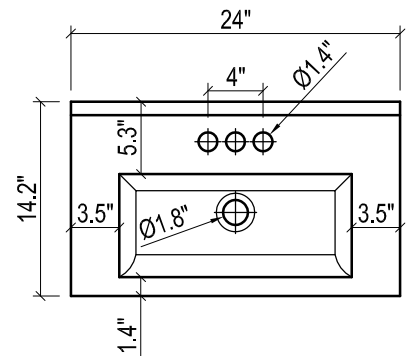
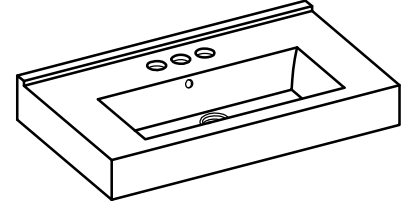

TOP VIEW

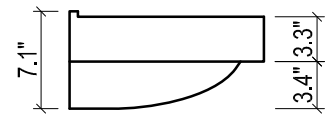

SIDE VIEW

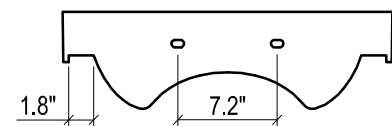

BACK VIEW