

**025803 J18**

Project name: \_\_\_\_\_

Specifier: \_\_\_\_\_ Contractor: \_\_\_\_\_

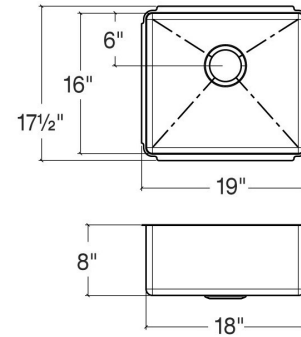

## Features

- Handcrafted in Canada using recycled American stainless steel
- Residential grade - 18 ga material thickness
- Corrosion resistant 304 series stainless steel (18/10)
- Elegant no. 4 brushed finish (appliance finish)
- Highly efficient sound deadening pads
- Practical flat sink bottom and straight bowl sides
- Stylish and functional bowl bottom grooves
- Rear 3-1/2" drain placement
- Limited lifetime warranty

## Standards compliance

- ASME A112.19.3
- CSA B45.0
- CSA B45.4

## Optional accessories

- Colander 205012
- Cutting board 210047
- Drain fitting 100056
- Drain fitting 100080
- Drain fitting 100081
- Drain fitting 100082
- Drain fitting 100083
- Grid 200303

## Sink dimensions

Model	Overall	Bowl	Depth	Cabinet Size*	Drain
<b>025803</b>	19" x 17 1/2"	18" x 16"	8"	24"	3 1/2"
<b>025818</b>	19" x 17 1/2"	18" x 16"	10"	24"	3 1/2"

\* Cabinet Size is the Recommended Cabinet Size

## Product specifications

Sink type to be undermount single bowl. Sink to be handcrafted from a single sheet of 18 ga stainless steel having 18/10 chrome/nickel content and a no.4 brushed finish. Sink to feature bowl bottom grooves, rear 3 1/2" drain placement and sound deadening pads. Sink overall dimensions to be 19" left-to-right and 17 1/2" front-to-back. Bowl dimensions to be 18" left-to-right and 16" front-to-back. Sink to feature 18mm radius corners. Sink to be Julien J18 collection model 025803 with bowl depth of 8".

## Warranty

Julien inc. offers a LIMITED LIFETIME WARRANTY on the fix components of its stainless steel sinks against defects of material and workmanship. For further details on our product warranty, please refer to our catalog or Web site.