



Product specifications

- **9 1/2" projection**
- Swivel spout 360°
- Optional restriction, swivels 150°
- 1 3/8" hole diameter
- Aerated and spray function
- Ceramic disc cartridge
- 2x Pressure hose M 8 x 1 x 23 5/8"
- 59" metal shower hose
- Hand spray with descaling system
- Water flow rate limited to max. 1.5 gpm
- low lead compliant

Internal backflow preventer.

[ADA]

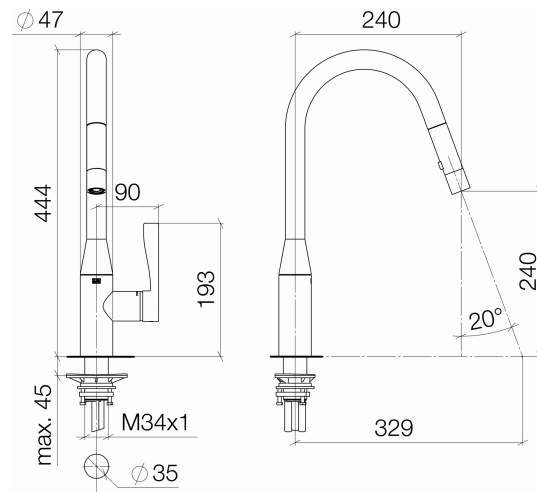

Surfaces

- chrome 33870895-000010
- matt platinum 33870895-060010

Exploded assembly drawing

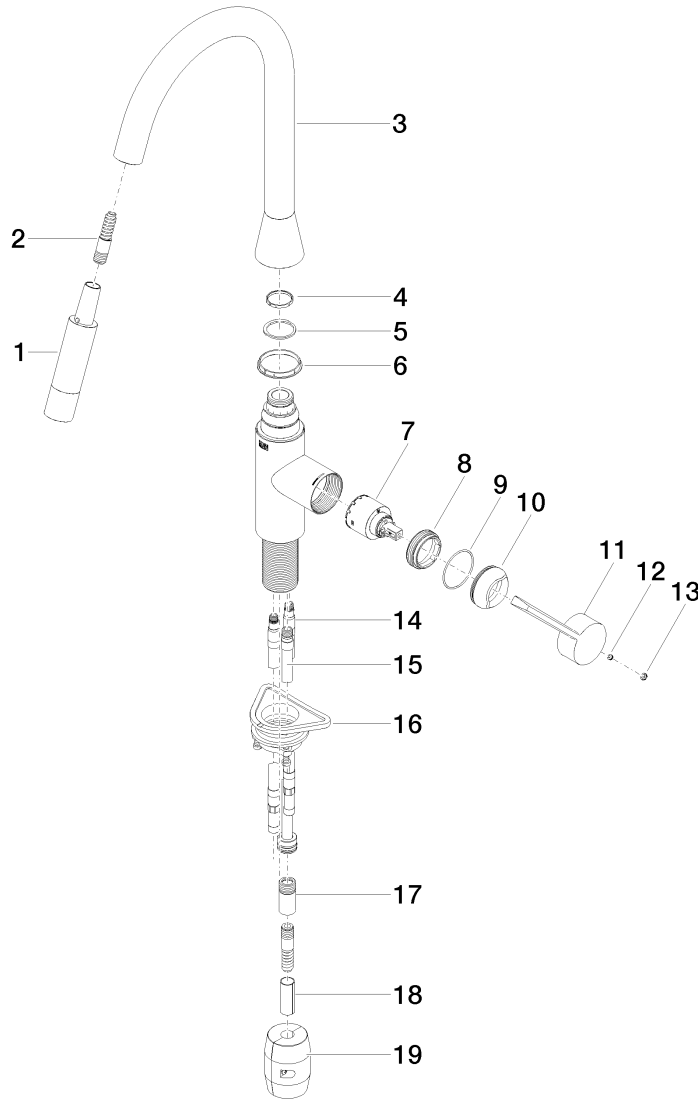

Order quantity

No.	Article number	Name	Installation quantity
1	04121114800ff	shower	1
2	04300212000ff	hose	1
3	90282230200ff	spout	1
4	09281016090	ring	1
5	09281016290	ring	1
6	09281016190	ring	1
7	09150506290	cartridge	1
8	09231007290	nut	1
9	09141019090	seal	1
10	092830030ff	cover	1
11	092089020ff	handle	1
12	09311106390	pin	1
13	90312008700ff	plug	1
14	0430040980090	hose	2
15	0428200660090	pipe	1
16	0430110400090	fixing set	1
17	9024032530090	adaptor	1
18	09300303890	hose	1
19	0421500100090	accessories	1

