

FEATURES:

- All brass construction with glass tumbler.
- Glass tumbler P/N: 18.18.023.
- Available in all Sigma finishes. Warranty varies according to finish selection.
- Mounting bracket and screws are supplied.

Series 22
Tumbler Holder
1.22TH00

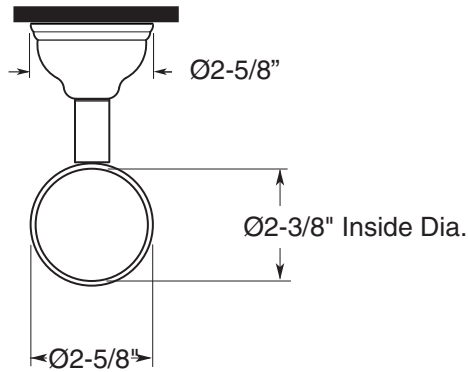

TOP VIEW

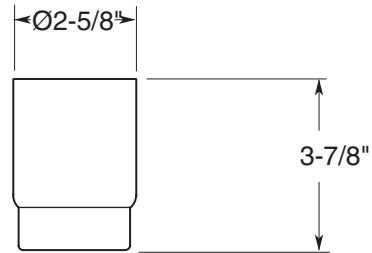

GLASS TUMBLER

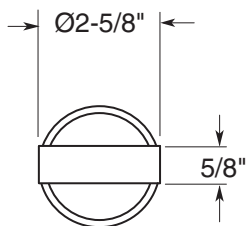

FRONT VIEW

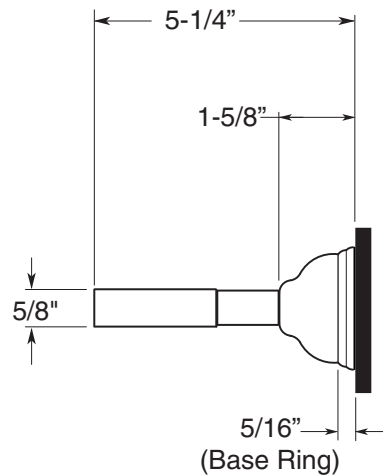

SIDE VIEW

Note: Measurements are subject to change or cancellation. No responsibility is assumed for use of superseded or voided pages.