

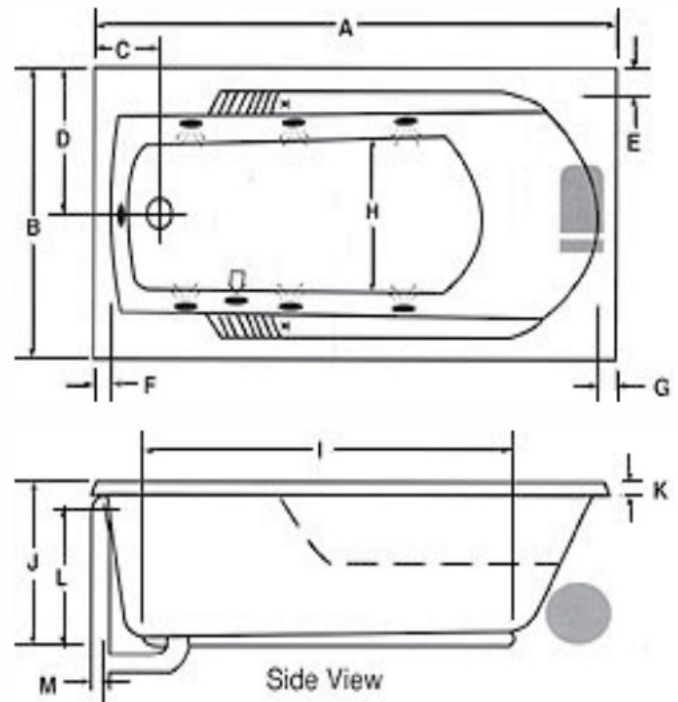



Isabella



Must be set in Mortar Base



-  Pump motor
-  Jets
-  Anti-vortex suction
-  Overflow location

AS SHOWN:
Whirlpool option w/ standard jets

ALSO AVAILABLE:
Soaking Tub Only,
Thermal Air, Combo

Side View

Model	GC	AC	A	B	C	D	E	F	G	H	I	J	K	L	M	Jet	Pump	Wat.Cap.
6036	N/A		59¾"	35¾"	8¼"	18"	2½"	2¼"	2¼"	22"	41½"	18¾"	1¾"	16¼"	1½"	6	2.25	50 gal.
6636	N/A		65¾"	35¾"	8½"	18"	2½"	2¼"	2¼"	22"	47½"	19"	1¾"	16½"	1½"	6	2.25	60 gal.
7236	N/A		71¾"	35¾"	8½"	18"	2½"	2¼"	2¼"	22"	53½"	18¾"	1¾"	16¼"	1½"	6	2.25	70 gal.
Amp	Volt	Breaker	Dedicated Service															
13.5	120	20 amp	GFCI Protected															

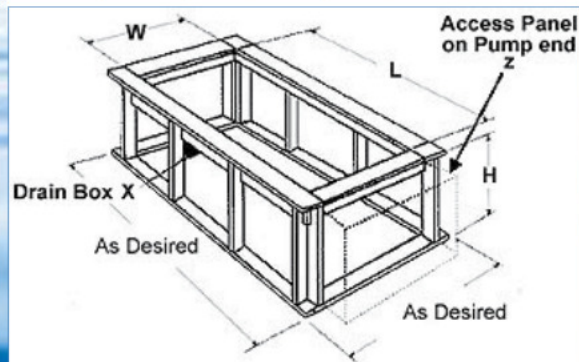

When altering the pump/blower location may cause the pump/blower to extend beyond the tub decking. For cutout dimensions wait for unit to arrive. All specifications subject to change without notice.

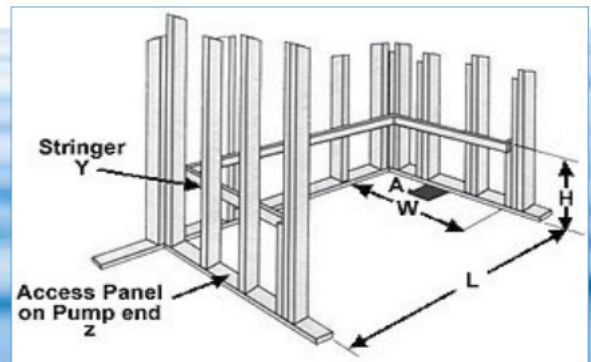

Island Drop-In				3 Wall Installation		
Model	(L)ength	(W)idth	(H)eighth Finish	(L)ength	(W)idth	(H)eighth Ledger Molded Flange
6036	57¾"	33¾"	18"	60"	36"	19½"
6636	63¾"	33¾"	18¼"	66"	36"	19¾"
7236	69¾"	33¾"	18"	70"	36"	19½"