

**11" PAULE RECTANGULAR
STAINLESS STEEL PREP SINK**

Cat. No
PSSSB2052-SS



W: 11"
D: 20"
H: 8"

Features:

- ▶ Solid 16 gauge, 304 grade metal construction
- ▶ Narrow space saving design
- ▶ Matte finish
- ▶ Coated for sound insulation
- ▶ Mounting clips and template included
- ▶ Lip is 1-1/16" wide
- ▶ Drain is 3-1/2"
- ▶ Drain sold separately

Compliance Certification
Meets or exceeds the following
specifications: ASME
A112.19.3-2001 for Stainless Steel.

***Please do NOT cut hole without
template or actual product.**

Interior Dimensions:

Basin Interior: 9" W x 18" D
Basin Depth: 7-1/2"

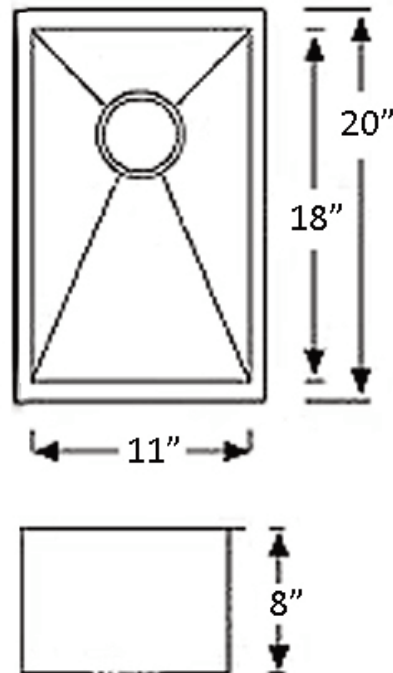

Dimensions of fixture are nominal and may vary within the range of tolerances established by ANSI Standard A112.19.2. Dimensions and specifications subject to change without notice.