

S-AS 99 Series

S-AS 99 | Site Sizeable

- Modify length and locate outlet on-site
- Indoor or outdoor use
- 316 Wedge Wire stainless steel grate
- Stainless Steel channel
- Works with 3" clamp down floor drain with 4" throat (strainer size)
- Uses Hot Mop, Lead Pan, PVC Vinyl Liner, Rubber Liner (Chloraloy™) Copper Pan or Fiberglass waterproofing
- Grate can be removed completely for cleaning
- Flow rate 21 GPM per outlet*

*Flow rate measured at outlet only. Measurement does not account for water in channel or sheeting on shower floor.

Finishes:

- Satin Stainless
- Polished Stainless

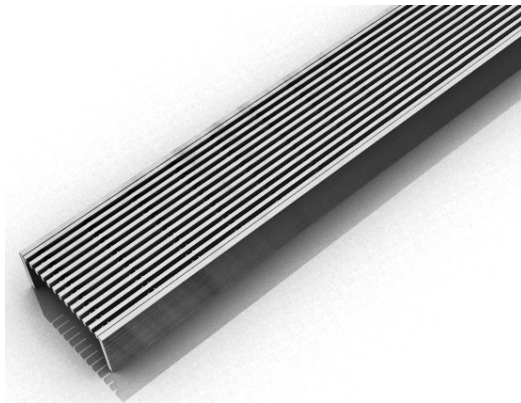

Installation (S) Site Sizable

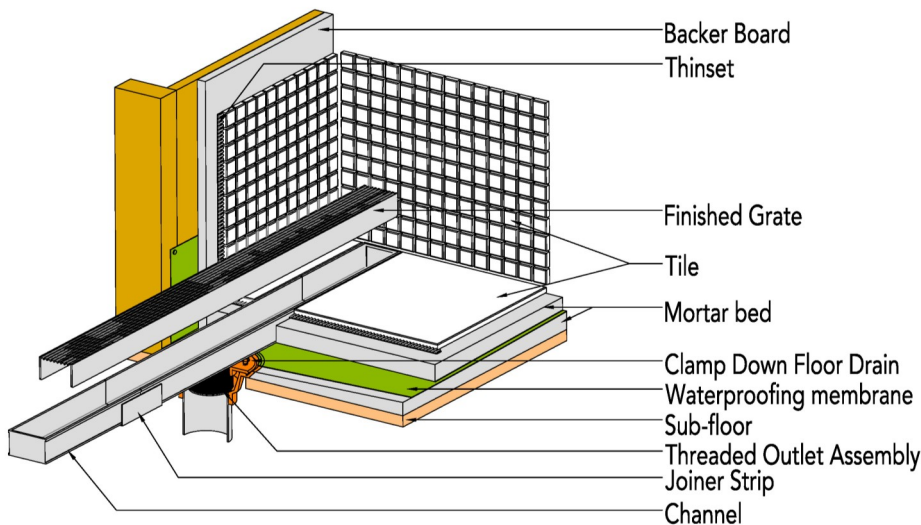

Complete Kits:

S-AS 9936	36" Complete Kit
S-AS 9948	48" Complete Kit
S-AS 9960	60" Complete Kit
S-AS 9972	72" Complete Kit
S-AS 9996	96" Complete Kit

Longer lengths for indoor or outdoor installations.

Components:

SA 6536	36" Stainless Steel Grate
SA 6548	48" Stainless Steel Grate
SA 6560	60" Stainless Steel Grate
SC 6548	48" Stainless Open Ended Channel
SC 6596	96" Stainless Open Ended Channel
LC 6528	28" Stainless Closed Ended Channel
LC 6540	40" Stainless Closed Ended Channel
LC 6552	52" Stainless Closed Ended Channel
LC 6564	64" Stainless Closed Ended Channel
LC 6588	88" Stainless Closed Ended Channel
LF 99	8" Stainless Steel Outlet Section
GJS 65	Stainless Steel Joiner Strip
SE 65	Stainless Steel End Section
TNAS	Threaded Nipple
Sikaflex	1a Construction Sealant
CDI 43	Cast Iron Drain Body

Additional Clamp Down Drains:

CDA 43	Clamp Down Drain ABS
CDP 43	Clamp Down Drain PVC
CDIT 43	Clamp Down Drain Cast Iron
CDIC 43	Clamp Down Drain Cast Iron

*Cast Iron Standard

Optional Components:

SLA 65	Stainless Steel 90° Angle Joiner
UCP 4	Universal 4" Clamping Plate

Note: Installer must verify all rough-in dimensions prior to installation and consult local and national codes. Conformity and compliance to local and national codes are the responsibility of the installer.

Infinity Drain
 18 Secatoag Avenue
 Port Washington, NY 11050
 Phone: 516.767.6786
 Fax: 516.740.3066
 www.InfinityDrain.com

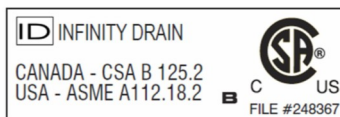

S-AS 9960 Specifications

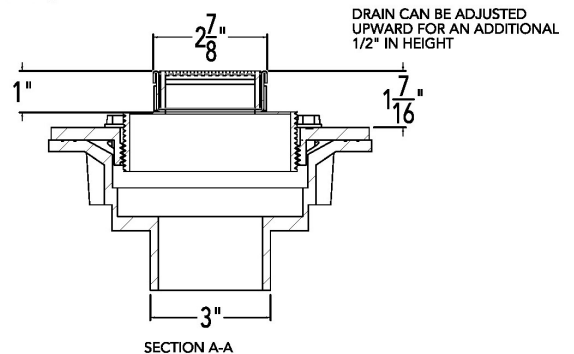
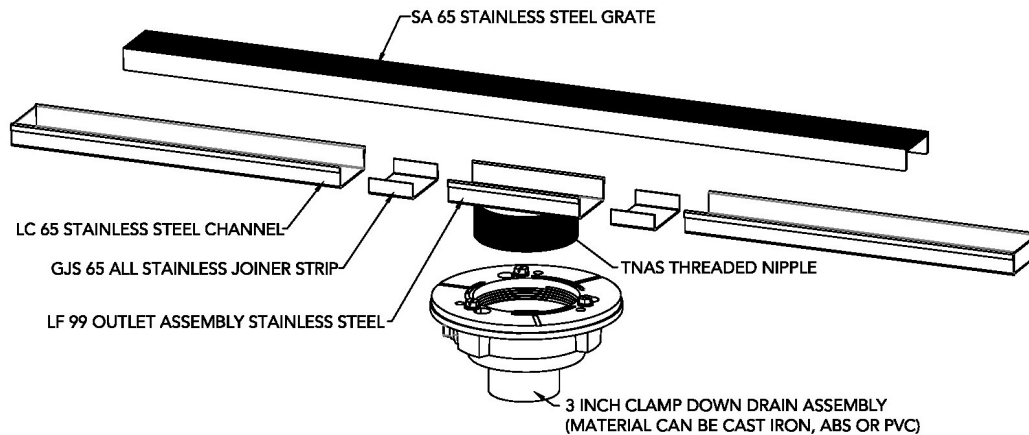
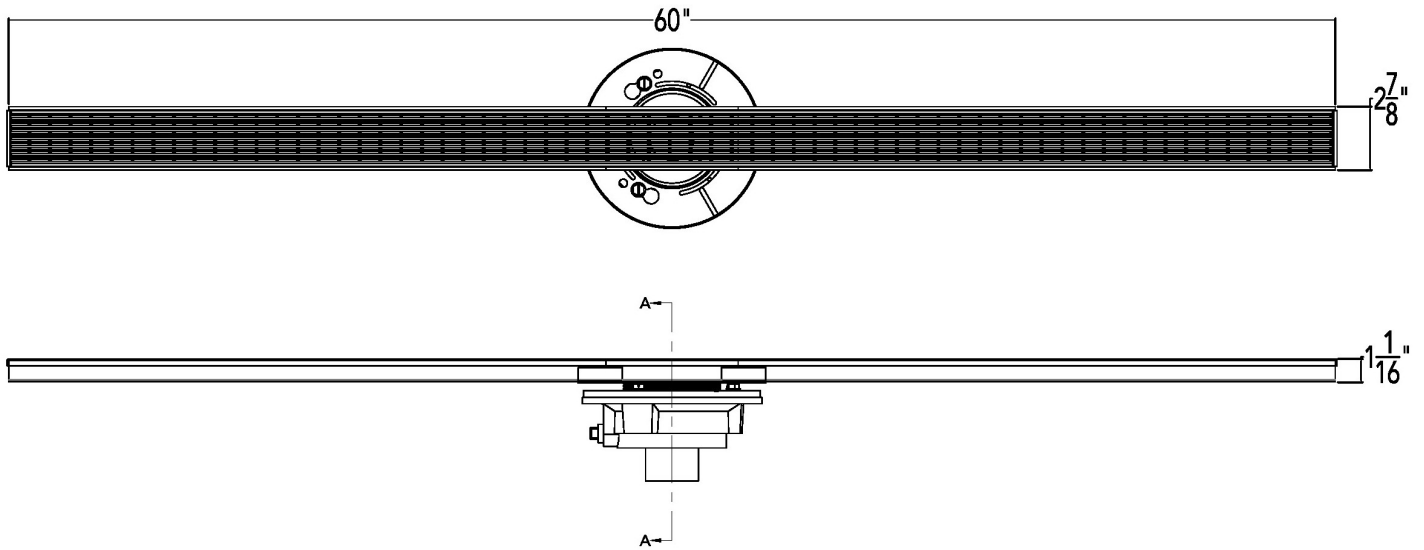

AS 9936

36" Complete Kit Includes:

(36 1/8" l x 2 7/8" w x 1" h)

- 1 - SA 6536 Stainless Steel Grate
- 1 - LC 6528 Stainless Steel Channel
- 1 - LF 99 8" Outlet Section Stainless Steel
- 2 - GJS 65 All Stainless Joiner Strip
- 1 - Sikaflex 1a Construction Sealant
- 1 - CDI 43 Cast Iron Drain Body

Infinity Drain

18 Secatoag Avenue
 Port Washington, NY 11050
 Phone: 516.767.6786
 Fax: 516.740.3066
 www.InfinityDrain.com

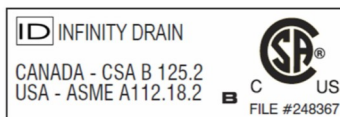

Note: Installer must verify all rough-in dimensions prior to installation and consult local and national codes. Conformity and compliance to local and national codes are the responsibility of the installer.