

**MODEL NUMBER:**

**TRIM KITS:**

- T064.430 Diverter Valve Trim**  
Valve Trim ONLY. LESS Valve.

**ROUGH VALVE BODIES:**

- R420 Two-Way In-Wall Diverter Valve Rough**  
1/2" NPT inlets/outlets. Less Handle.
- R430 Three-Way In-Wall Diverter Valve Rough**  
1/2" NPT inlets/outlets. Less Handle.

**NOTE:** Cannot be used as a shut-off valve.

**ALL CONNECTIONS 1/2" NPT**

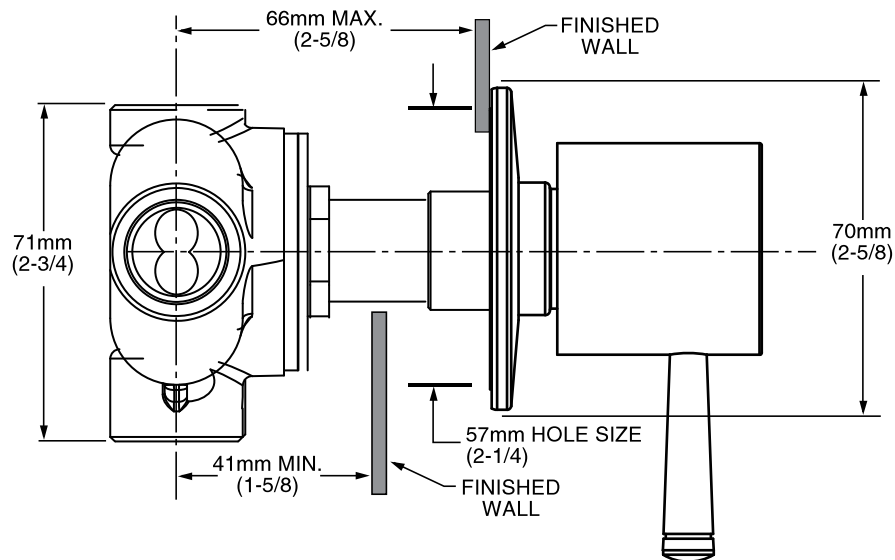

**GENERAL DESCRIPTION:**

In-Wall Diverter: Rotational control alternates water flow between two (R420) or three (R430) different shower outlets (i.e. showerhead, handspray, body side spray or tub spout). Forged brass valve body. Mixed water inlet and two (R420) or three (R430) outlets are marked on back of valve body. 1/2" NPT connections on mixed water inlet and two (R420) or three (R430) outlets. Stamped brass escutcheon. Tub port with increased water flow (see chart).

**NOTE:** Cannot be used as a shut-off valve.

**PRODUCT FEATURES:**

**Solid Brass Construction:** Durable, ideal material for prolonged contact with water.

**Removable Plaster Guard:** Permits checking of valve installation prior to installing trim parts.

**Choice of Finishes:** Wide range of durable finishes.

**SUGGESTED SPECIFICATION**

Two (three) way diverter shall feature a forged brass body with 1/2" NPT mixed water inlet and outlets. Fitting shall be American Standard Model # T064.430.\_\_\_\_ (Diverter Valve Trim) and R4\_0. (Rough Valve Body).