

# SAMUEL HEATH

**Product Number:** V7KA44-1LL-CP

**Description:** 3 Hole tub filler, 5 7/8" spout length

## Standards



## Flow rates

Gallons/Min	1.5 PSI	7.3 PSI	14.5 PSI	29.0 PSI	43.5 PSI	58.0 PSI	72.5 PSI
			5.5	7.5	11.9	13.9	15.6

Flow rate data provided is indicative of each product and is given in open outlet conditions. Installation design, external connections and fittings not supplied may affect the data provided.



## Finishes Available



## Control Options Available



## Specification Drawing

SPOUT LENGTHS:

V7KA44-1: A = 6 1/2in  
B = 5 7/8in

V7KA44-2: A = 8 5/16in  
B = 7 11/16in

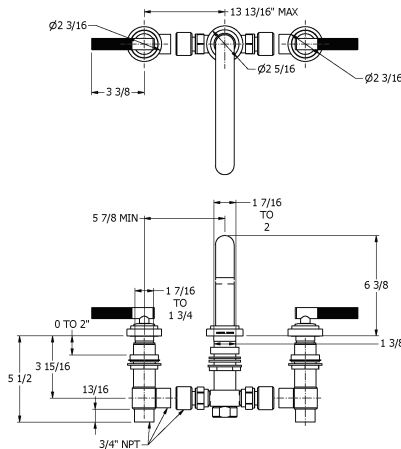
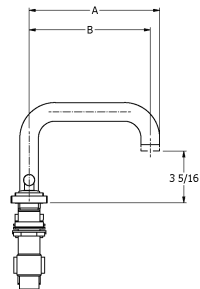

**UK Customer Service**  
Leopold Street  
Birmingham  
B12 0UJ  
Tel: +44 121 766 4200  
Email: info@samuel-heath.com

**US Customer Service**  
Federal I.D. No. 58-1504682  
Email: usa@samuel-heath.com

**Specification Enquiries**  
Design Centre Chelsea Harbour  
1st Floor, North Dome, London  
SW10 0XE  
Tel: 020 7352 0249  
Email: showroom@samuel-heath.com