

SAMUEL HEATH

Product Number: V702-TLF-CP

Description: Trim set for V135-AIS thermostatic valve - 2 separate volume controls



Standards



Flow rates

Gallons/Min	1.5 PSI	7.3 PSI	14.5 PSI	29.0 PSI	43.5 PSI	58.0 PSI	72.5 PSI
1/2" Feed		3.1	4.5	7.0	8.5	9.5	10.7
3/4" Feed		3.1	4.5	7.0	8.5	9.5	10.7

Flow rate data provided is indicative of each product and is given in open outlet conditions. Installation design, external connections and fittings not supplied may affect the data provided.

Finishes Available



Control Options Available



Specification Drawing

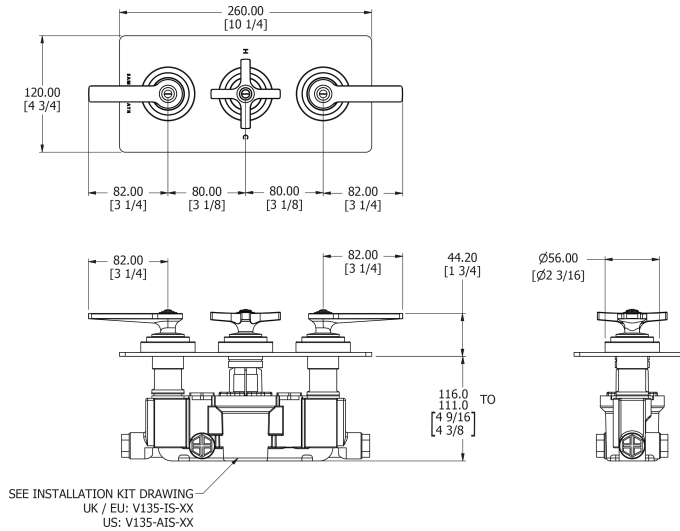

UK Customer Service
 Leopold Street
 Birmingham
 B12 0UJ
 Tel: +44 121 766 4200
 Email: info@samuel-heath.com

US Customer Service
 Federal I.D. No. 58-1504682
 Email: usa@samuel-heath.com

Specification Enquiries
 Design Centre Chelsea Harbour
 1st Floor, North Dome, London
 SW10 0XE
 Tel: 020 7352 0249
 Email: showroom@samuel-heath.com