

SAMUEL HEATH

Product Number: V2K4AXM12

Description: Exposed 1/2" thermostatic shower set - bath spout and diverter



Standards



Finishes Available



Specification Drawing

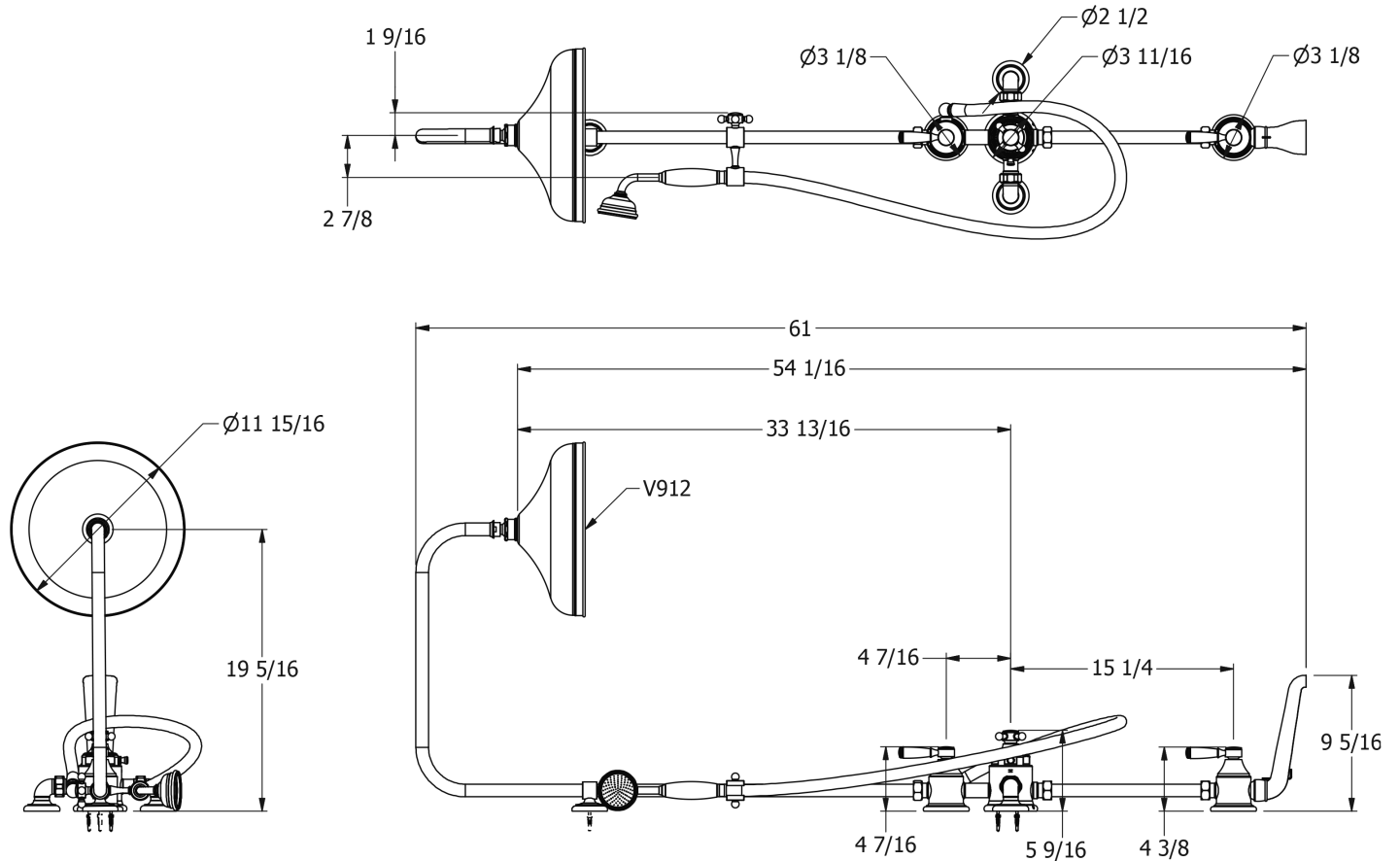

UK Customer Service
 Leopold Street
 Birmingham
 B12 0UJ
 Tel: +44 121 766 4200
 Email: info@samuel-heath.com

US Customer Service
 Federal I.D. No. 58-1504682
 Email: usa@samuel-heath.com

Specification Enquiries
 Design Centre Chelsea Harbour
 1st Floor, North Dome, London
 SW10 0XE
 Tel: 020 7352 0249
 Email: showroom@samuel-heath.com

1-30/04/2024