

# SAMUEL HEATH

**Product Number:** V2K3AGC12

**Description:** Exposed 1/2" thermostatic shower set - bath spout and shower



## Standards



## Finishes Available



## Specification Drawing

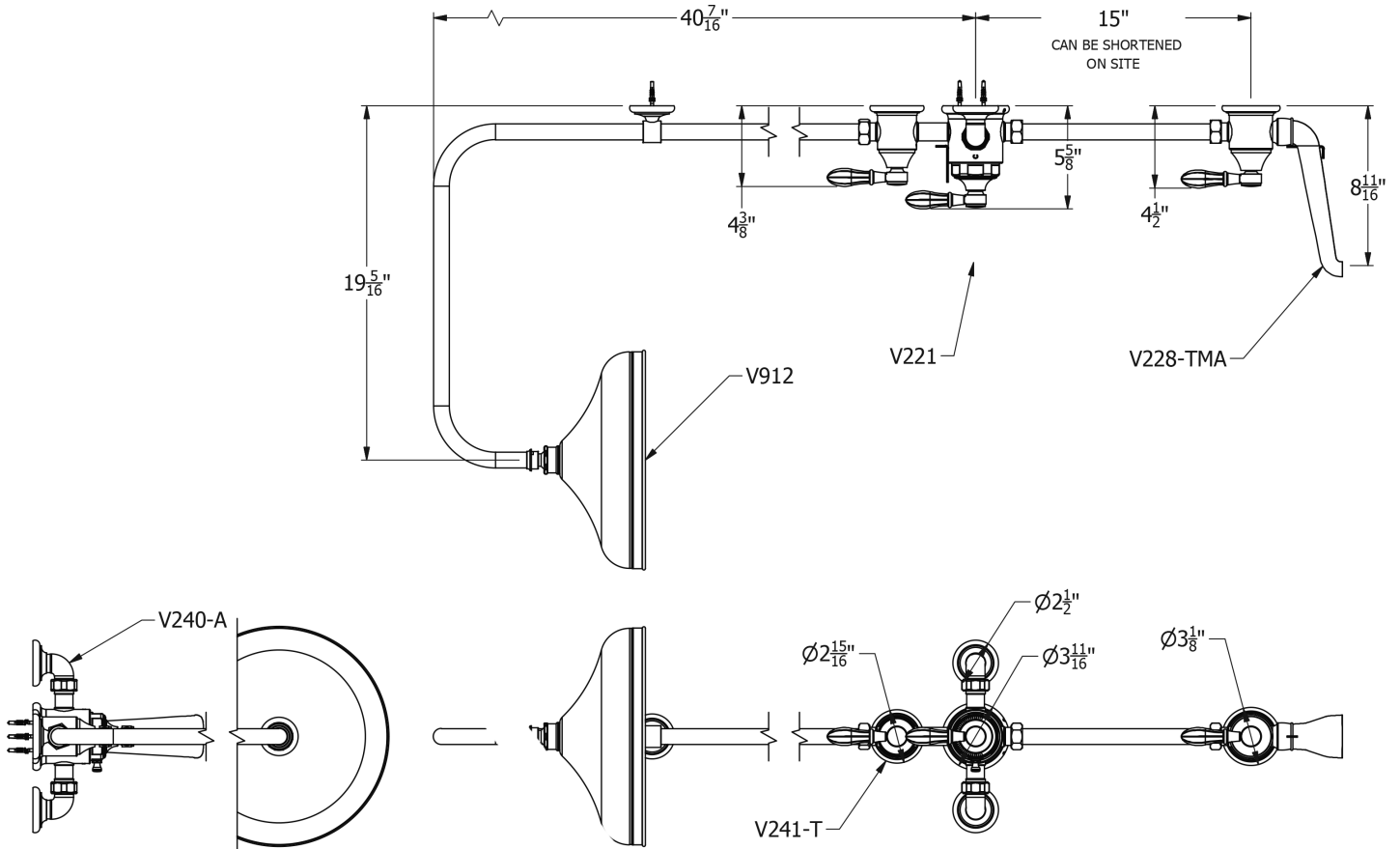

**UK Customer Service**  
 Leopold Street  
 Birmingham  
 B12 0UJ  
 Tel: +44 121 766 4200  
 Email: info@samuel-heath.com

**US Customer Service**  
 Federal I.D. No. 58-1504682  
 Email: usa@samuel-heath.com

**Specification Enquiries**  
 Design Centre Chelsea Harbour  
 1st Floor, North Dome, London  
 SW10 0XE  
 Tel: 020 7352 0249  
 Email: showroom@samuel-heath.com