

SAMUEL HEATH

Product Number: V2B1AXM9

Description: 1/2" Concealed thermostatic shower - 2 volume controls



Standards



Finishes Available



Chrome Plate



Polished Nickel



Non Lacquered Brass



Antique Gold



Satin Nickel (US15)



City Bronze



Country Bronze



Brushed Gold Gloss



Brushed Gold Matt



Brushed Gold Unlacquered



Antique Brass Matt



Antique Brass Gloss



Amber Brass

Specification Drawing

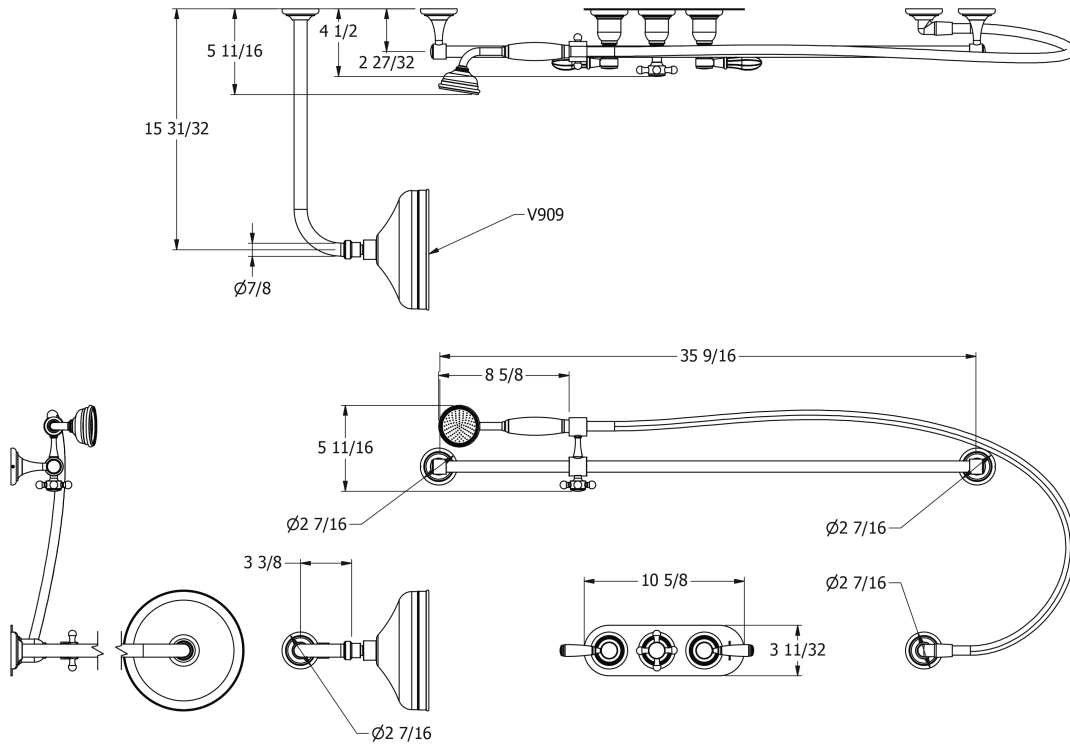

UK Customer Service

Leopold Street
Birmingham
B12 0UJ
Tel: +44 121 766 4200
Email: info@samuel-heath.com

US Customer Service

Federal I.D. No. 58-1504682
Email: usa@samuel-heath.com

Specification Enquiries

Design Centre Chelsea Harbour
1st Floor, North Dome, London
SW10 0XE
Tel: 020 7352 0249
Email: showroom@samuel-heath.com