

# SAMUEL HEATH

**Product Number:** N1037

**Description:** Paper holder



## Finishes Available



## Specification Drawing

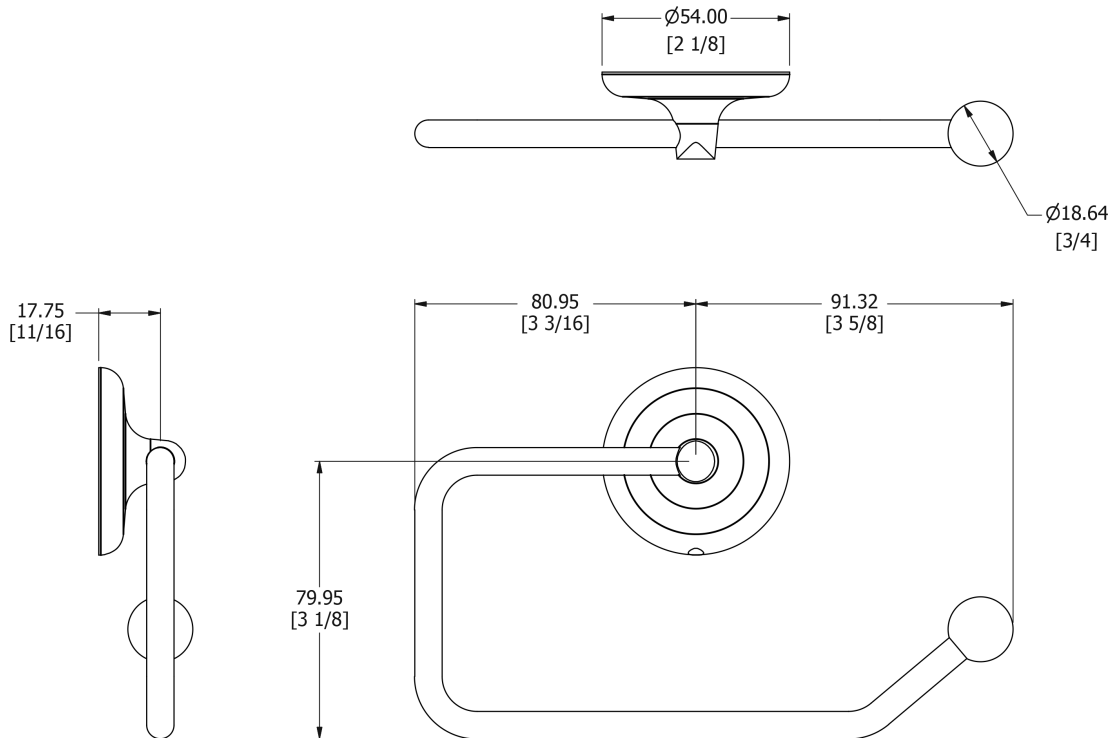

**UK Customer Service**  
Leopold Street  
Birmingham  
B12 0UJ  
Tel: +44 121 766 4200  
Email: info@samuel-heath.com

**US Customer Service**  
Federal I.D. No. 58-1504682  
Email: usa@samuel-heath.com

**Specification Enquiries**  
Design Centre Chelsea Harbour  
1st Floor, North Dome, London  
SW10 0XE  
Tel: 020 7352 0249  
Email: showroom@samuel-heath.com

1-30/04/2024