

# CRESCENT MCFS-655GPSB

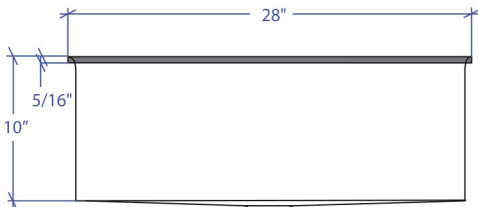

\*Flush-Mount Installation Kit is included with each sink  
 \*Custom ADA compliant versions are available

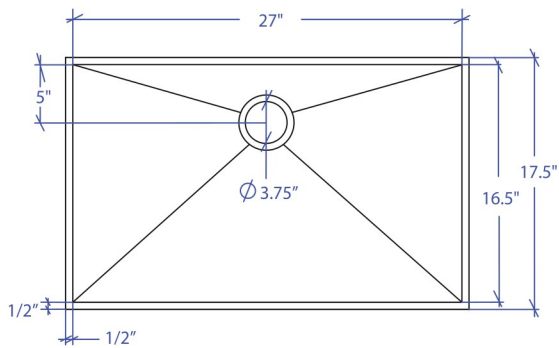

## • FEATURES

- 16-gauge type 304 stainless steel
- Stainless steel rim support tubing
- 1/4" round rim and basin design

## • TECHNICAL INFORMATION

- External dimension: 28"Lx17.5"Wx10"D
- Basin dimensions: 27"Lx16.5"Wx10"D
- Rim width: 1/2"
- Rim thickness: 5/16"

## • FINISHES

- Graphite PVD satin brushed stainless steel

## • INSTALLATION OPTIONS

- Flush-mount

## • MINIMUM CABINET SIZE (I.D.)

- Flush-mount 31"

## • INDUSTRY'S ONLY STAINLESS STEEL SINK DESIGNED SPECIFICALLY TO BE FLUSH-MOUNTED

## • INTERNATIONAL PATENT PENDING

## • FLUSH-MOUNT INSTALLATION

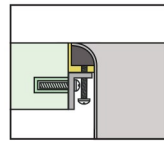

Flush-mount

## • ACCESSORIES OPTIONS

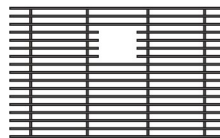

MBG-6517GPSB  
Basin Grid

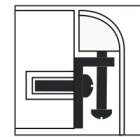

Flush Mount Kit  
(Included)  
MTK-618AL

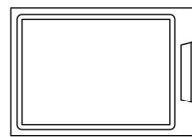

MCB-651BB  
Cutting Board

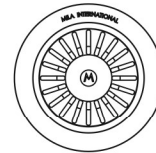

MKD-101GPSB  
Strainer

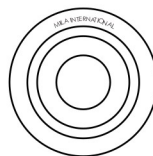

MDC-101GPSB  
Disposal Collar

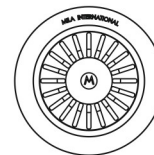

MDC-102GPSB  
Disposal Collar

## PROJECT INFORMATION

Project			
Date	/ /	QTY	
Specifier			
Contact			
Note			