

Product Specs Sheets

Cover Page

Lotus C60F

Features

- Complete Vanity Unit
- Base Unit Available in 4 Finishes: Glossy White, Natural Oak, Mist Matte, and Walnut
- Handles in Matte Black
- Free Standing Installation with Matte Black Legs
- Two soft close drawers
- Includes integrated sink and vanity top in gloss white ceramic with faucet hole and overflow
- Fully assembled with structure and front made of engineered wood in wood finishes and high gloss lacquered
- Handle integrated in front of furniture
- Drawers with Full Extraction
- Made in Spain







Related Items:

- WSBC 53991 | Push Waste Drain
- WSBC 53922 | Decorative Trap
- Lotus COL02 | Bathroom Column

SKU# | Options:

- Lotus C60F.112 WG | Glossy White
- Lotus C60F.112 NO | Natural Oak
- Lotus C60F.112 MTM | Mist Matte
- Lotus C60F.112 WA | Walnut

Finishes:

-  Glossy White
-  Natural Oak
-  Mist Matte
-  Walnut

Codes & Standards:

- CARB2 Compliant and Certified
- TSCA Compliant and Certified

* WS Bath Collections reserve the right to make revisions without notice to product specifications, dimensions, or information.

Collection |
Lotus

Model |
Lotus C60F

Dimensions Metric

1 inch = 2.54 cm

1 inch = 25.4 mm

WS®
BATH
COLLECTIONS

1051 Lea Drive - Collegeville, PA 19426
Tel. 215 513 9400 - Fax 610 831 0215

www.ws bathcollections.com - info@ws bathcollections.com

Lotus C60F

Sink

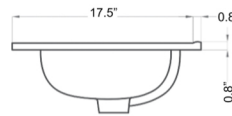
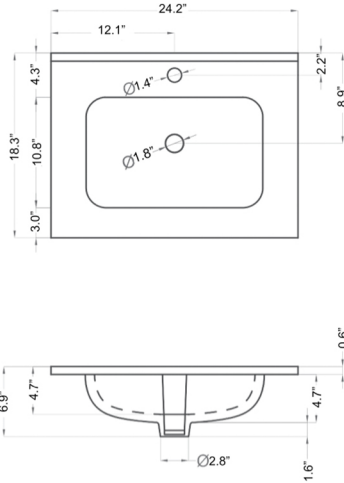

Base Unit

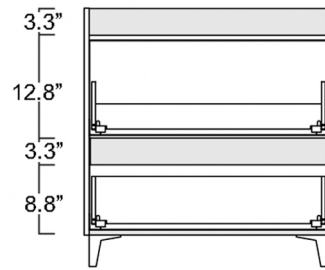
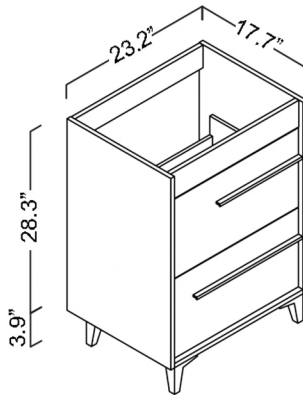

FRONT 16 mm.
SIDE PANELS 16 mm.

Technical information



Total extraction
Extracción total
Extraction totale



Laminated texture
Textura laminada
Laminé texture



Soft close
Cierre amortiguado
Fermeture ralentie

Collection |
Lotus

Model |
Lotus C60F

Dimensions Metric

1 inch = 2.54 cm
1 inch = 25.4 mm



1051 Lea Drive - Collegeville, PA 19426
Tel. 215 513 9400 - Fax 610 831 0215
www.ws bathcollections.com - info@ws bathcollections.com

We recommend the following items that work with your sink.

Lotus C60F

TRAPS



WSBC 53922
Our best seller

-  Polished Chrome
WSBC 53922.29
-  Matte Black
WSBC 53922.22
-  Glossy White
WSBC 53922.09
-  Matte White
WSBC 53922.26



WSBC 5392

-  Polished Chrome
WSBC 5392.29



WSBC 53925

-  Polished Chrome
WSBC 53925.29



WSBC 53921
Space saving

-  Polished Chrome
WSBC 53921.29
-  Matte Black
WSBC 53921.22
-  Glossy White
WSBC 53921.09
-  Matte White
WSBC 53921.26

DRAINS



WSBC 53991
Push waste drain (click clack)
with overflow

-  Polished Chrome
WSBC 53991.29
-  Glossy White
WSBC 53991.09
-  Glossy Black
WSBC 53991.18
-  Matte White
WSBC 53991.26
-  Matte Black
WSBC 53991.22

MOUNTING HARDWARE

Wall-Mount Installation

Vessel/Countertop Installation



Bolts



Silicone (optional)

Collection |
Lotus

Model |
Lotus C60F

Dimensions Metric

1 inch = 2.54 cm

1 inch = 25.4 mm

WS[®]
BATH
COLLECTIONS

1051 Lea Drive - Collegeville, PA 19426
Tel. 215 513 9400 - Fax 610 831 0215

www.ws bathcollections.com - info@ws bathcollections.com