

JULIEN

SM005729 | SMARTSTATION® SET

UNDERMOUNT SINGLE-BOWL WORKSTATION KITCHEN SINK WITH ACCESSORIES, FRONT-TO-BACK 18"

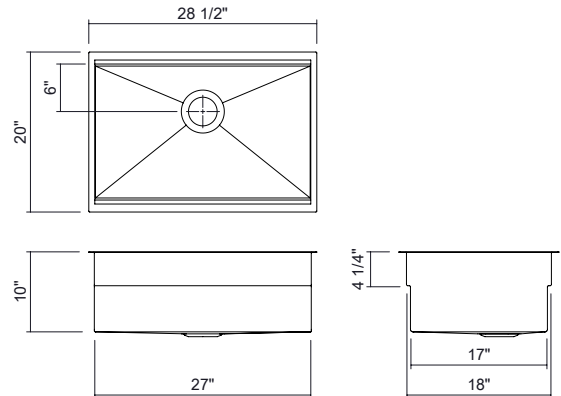

Specifications

Model	SM005729
Collection	SmartStation®
Bowl dimensions	27" x 18" x 10"
Overall dimensions	28.5" x 20" x 10"
Recommended cabinet	33"
Accessories material	Maple Hardwood
Installation options	Reveal 1/2" Overhang 1/8"

Included accessories

Cutting board	SM245103
Multi-tier bowl and colander set	SM245209
12" drying rack	SM245203
Grid	SM200967

Recommended accessories

	Premium XL cutting board	SM245101
	All-purpose chill & thaw bin	SM245211
	6" colander	SM245207
	6" drying rack	SM245202, SM245200
	12" drying rack	SM245205
	Drain	100082

Features

- This set includes the following accessories: 12-inch Cutting board, 12-inch drying rack and a multi-prep bowl & colander set.
- Proudly handcrafted in Canada.
- Commercial-grade 304 (18/10) stainless steel, 16-gauge thickness with a No. 4 brushed finish, providing strength, corrosion resistance, and seamless integration with appliances.
- Premium sustainable material, 100% recyclable.
- Two installation options optimized for any countertop thickness: overhang or reveal.
- Two-tier workstation: lower tier with a ledge inside the sink, and upper tier with a ledge positioned for reveal installation or designed for countertop use in overhang installation.
- Sink combining the style of the UrbanEdge® and J7® collections: square vertical corners and rounded bottom angles for easier cleaning and water drainage, improving hygiene and maintenance.
- Enhanced noise reduction with our integrated sound-absorption technology, which reduces noise while helping maintain water temperature.
- Flat bottom and straight sides for optimized space, with elegant grooves that facilitate water drainage.
- Rear or side 3-1/2-inch drain placement.
- Certifications: ASME A112.19.3, CSA B45.0, CSA B45.4.

Warranty

JULIEN Inc. offers a LIMITED LIFETIME WARRANTY on the fixed components of its stainless steel sinks against defects of material and workmanship as well as a 1-YEAR LIMITED WARRANTY following the purchase date for all accessories against defects of material and workmanship. This warranty is limited to defects or damages resulting from a normal residential use. For further details on our product warranty, please refer to our catalog or web site.