

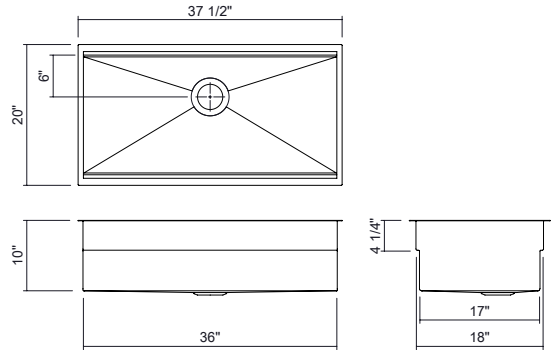

JULIEN

## SM005532 | SMARTSTATION®

UNDERMOUNT SINGLE-BOWL WORKSTATION STAINLESS STEEL KITCHEN SINK, FRONT-TO-BACK 18"

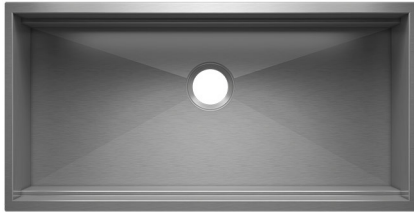

### Specifications

Model	SM005532
Collection	SmartStation®
Bowl dimensions	36" x 18" x 10"
Overall dimensions	37.5" x 20" x 10"
Recommended cabinet	42"
Installation options	 Reveal 1/2"  Overhang 1/8"

### Recommended accessories

Drain	100082
Grid	SM200971

Enhance your sink with perfectly compatible accessories



### Features

- Proudly handcrafted in Canada.
- Commercial-grade 304 (18/10) stainless steel, 16-gauge thickness with a No. 4 brushed finish, providing strength, corrosion resistance, and seamless integration with appliances.
- Premium sustainable material, 100% recyclable.
- Two installation options optimized for any countertop thickness: overhang or reveal.
- Two-tier workstation: lower tier with a ledge inside the sink, and upper tier with a ledge positioned for reveal installation or designed for countertop use in overhang installation.
- Unique design allowing the accessories to slide one over the other on two levels.
- The collection comes with a wide range of accessories, both practical and refined, designed to simplify preparation, serving, and storage while enhancing the culinary experience.
- Sink combining the style of the UrbanEdge® and J7® collections: square vertical corners and rounded bottom angles for easier cleaning and water drainage, improving hygiene and maintenance.
- Enhanced noise reduction with our integrated sound-absorption technology, which reduces noise while helping maintain water temperature.
- Flat bottom and straight sides for optimized space, with elegant grooves that facilitate water drainage.
- Rear or side 3-1/2-inch drain placement.
- Certifications: ASME A112.19.3, CSA B45.0, CSA B45.4.

### Warranty

JULIEN Inc. offers a LIMITED LIFETIME WARRANTY on the fixed components of its stainless steel sinks against defects of material and workmanship as well as a 1-YEAR LIMITED WARRANTY following the purchase date for all accessories against defects of material and workmanship. This warranty is limited to defects or damages resulting from a normal residential use. For further details on our product warranty, please refer to our catalog or web site.