

WATERMARK

BROOKLYN, NEW YORK



Thea 45-8.3-TA6

Floor Mounted Exposed Bath Set with Gooseneck Spout and Hand Shower

- Tub Spout Flow Rate: Full Flow
- Hand Shower Flow Rate: 1.75 GPM Max @ 45-80 PSI
- Requires: SS-FL8.3 Floor Rough-In
- Solid brass construction with Fluehs quarter-turn ceramic disc cartridges
- Professional installation recommended
- Some building codes require upstream installation of tempering valve conforming to ASSE 1070.

Available in all finishes shown on the [Watermark Designs website](https://www.watermark-designs.com)

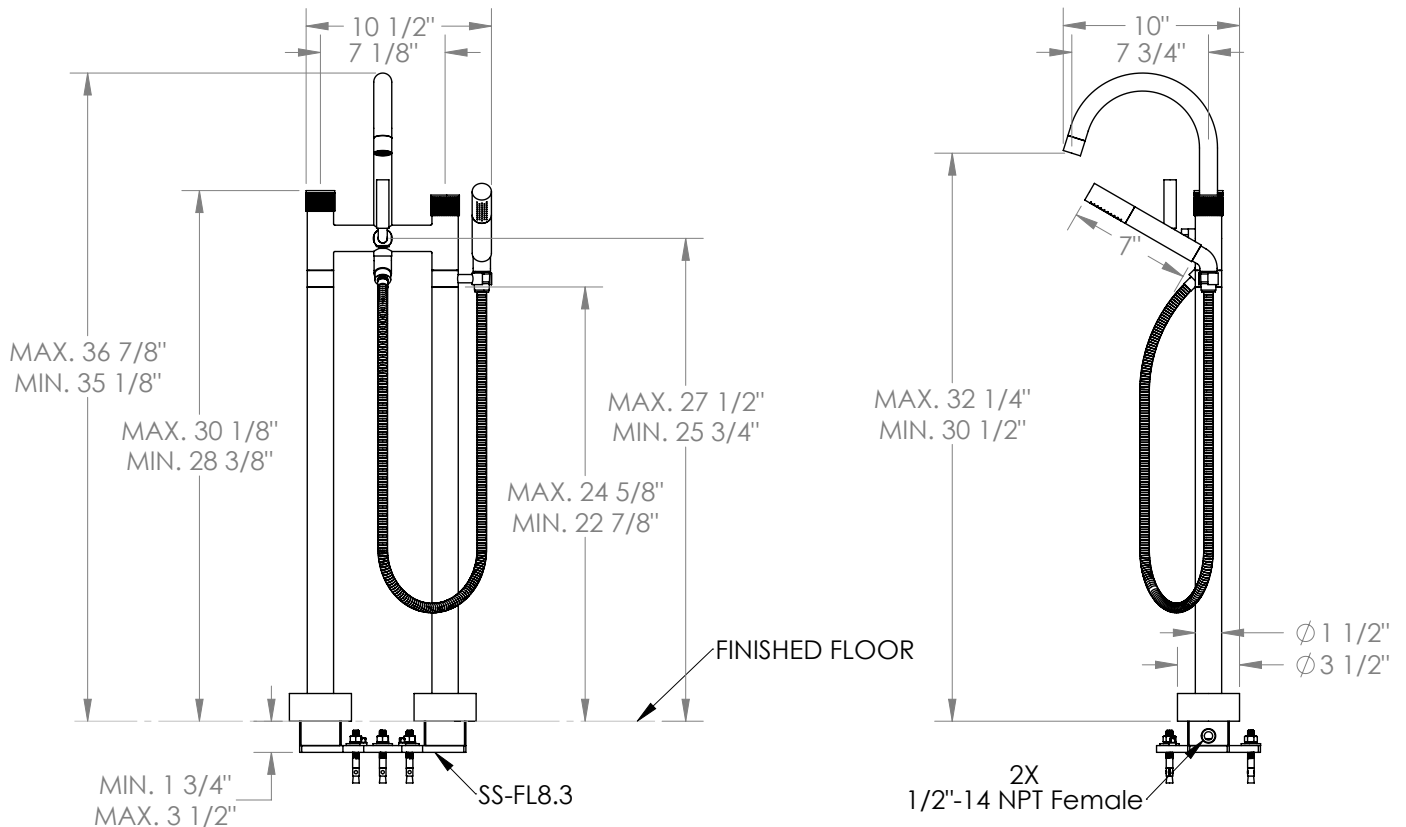

Meets the applicable requirements of ASME A112.18.1/CSA B125.1, entitled "Plumbing Supply Fittings".

Watermark Designs reserves the right to make revisions without notice to product specifications. All product dimensions are nominal.

Updated: 07/2025

350 Dewitt Ave. Brooklyn, NY 11207 USA | T: 1 718 257 2800 | F: 1 718 257 2144 | customerservice@watermark-designs.com