

WATERMARK

BROOKLYN, NEW YORK

Thea 45-7G-TA6

Deck Mounted Three Hole Kitchen Faucet with
Gooseneck Spout



- Flow Rate: 1.75 GPM Max @ 45-80 PSI
- Recommended Hole Size: 1 3/8"
- Maximum Deck Thickness: 2 3/8"
- Lead-free brass construction with Fluehs quarter-turn ceramic disc valves
- Includes flexible supply hoses for connecting valves to spout
- 360° swivel spout
- Professional installation recommended

Available in all finishes shown on the [Watermark Designs website](#)

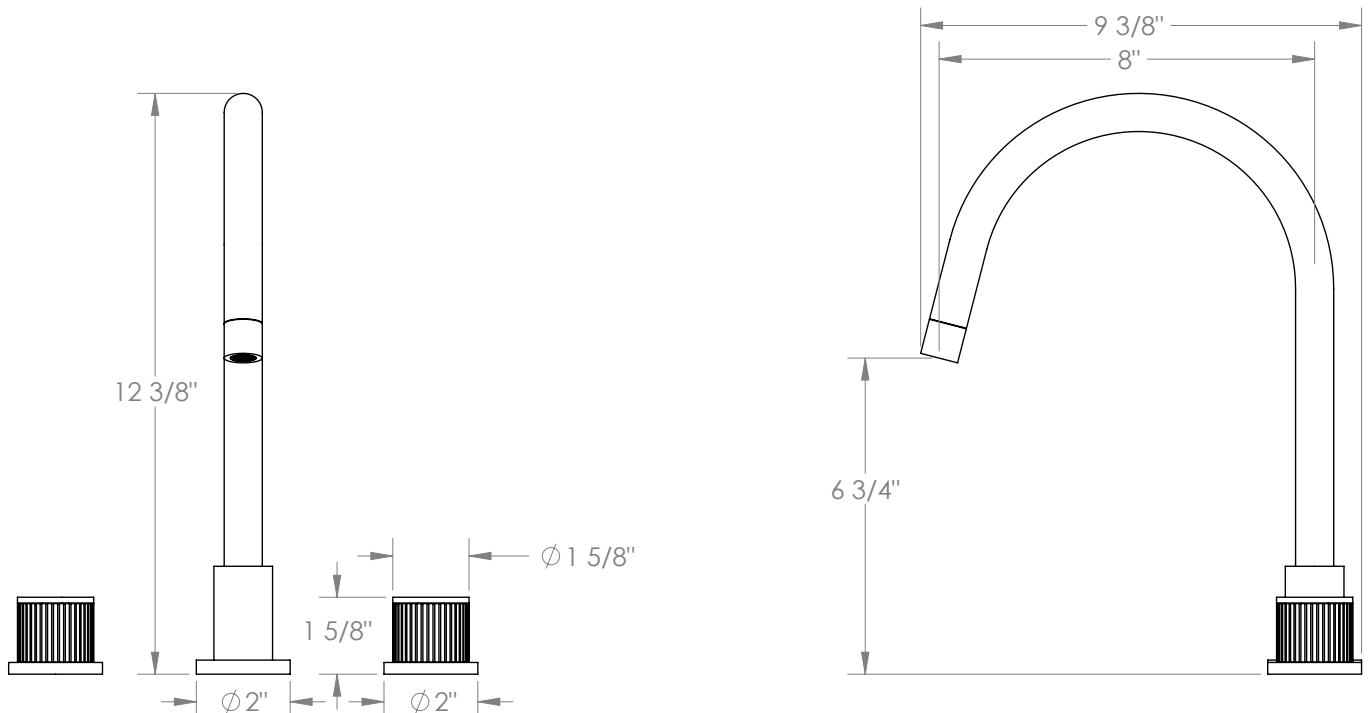

Meets the applicable requirements of ASME A112.18.1/CSA B125.1, entitled "Plumbing Supply Fittings".

Watermark Designs reserves the right to make revisions without notice to product specifications. All product dimensions are nominal.

Updated: 07/2025

350 Dewitt Ave. Brooklyn, NY 11207 USA | T: 1 718 257 2800 | F: 1 718 257 2144 | customerservice@watermark-designs.com