

165-76

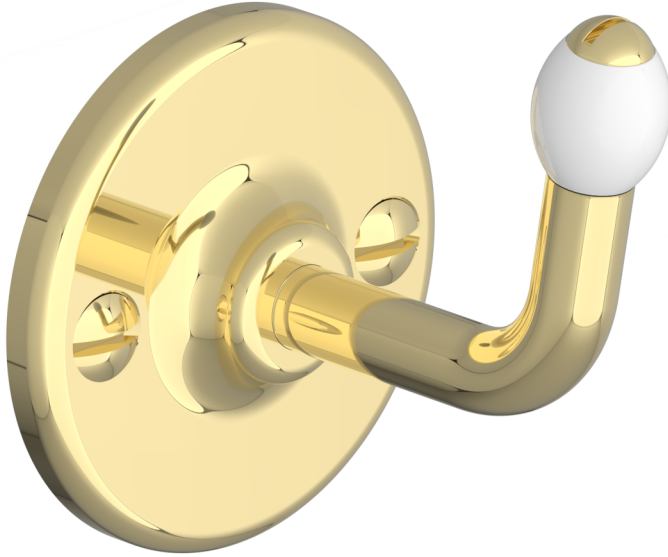

■ **PRODUCT FEATURES**

- Style: Transitional
- Collection: Jamestown
- 
- 
- 

■ **TECHNICAL DETAILS**

ADA Compliance: No  
 Installation Type: Wall Mounted  
 Primary Material: Brass

■ **PRODUCT DIMENSIONS**

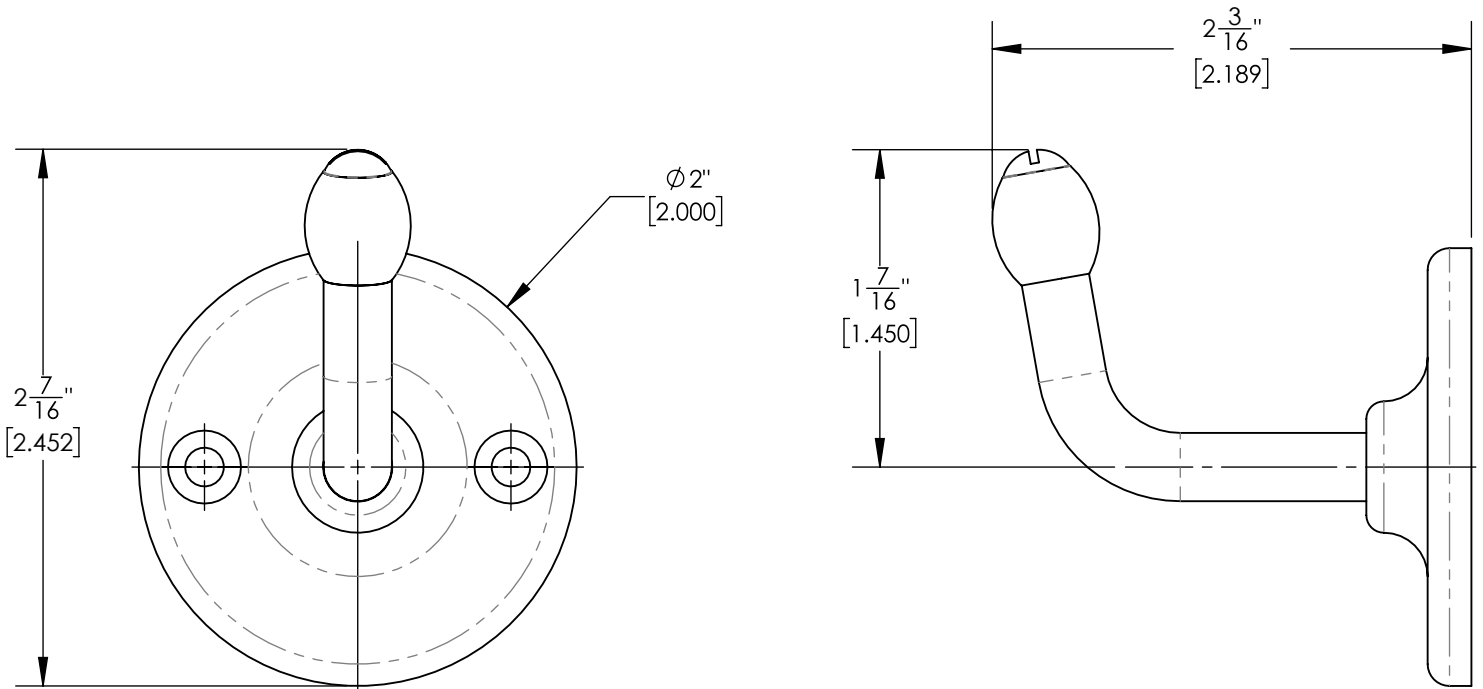

[www.phylrich.com](http://www.phylrich.com)

1261 Logan Avenue, Costa Mesa, California 92626.  
Phone: 714.361.4800 Fax: 714.617.3120



**CODES & STANDARDS**

ASME A112.181/ CSA B1251, ASME 112.18.2/ CSA B125.2, ANSI NSF, CEC

**WARRANTY**

Mechanical Warranty: 10 Years from date of purchase.  
 Finish Warranty: See catalog for further information.

Rev-